



Programmable Controller

MELSEC iQ-F
series



MELSEC iQ-F
FX5 User's Manual (Startup)

SAFETY PRECAUTIONS

(Read these precautions before use.)

Before using this product, please read this manual and the relevant manuals introduced in this manual carefully and pay full attention to safety in order to handle the product correctly.

This manual classifies the safety precautions into two categories: [⚠️ WARNING] and [⚠️ CAUTION].

 WARNING	Indicates that incorrect handling may cause hazardous conditions, resulting in death or severe injury.
 CAUTION	Indicates that incorrect handling may cause hazardous conditions, resulting in minor or moderate injury or property damage.

Depending on the circumstances, procedures indicated by [⚠️ CAUTION] may also cause severe injury.

It is important to follow all precautions for personal safety.

Store this manual in a safe place so that it can be read whenever necessary. Always forward it to the end user.

[DESIGN PRECAUTIONS]

WARNING

- Make sure to set up the following safety circuits outside the PLC to ensure safe system operation even during external power supply problems or PLC failure. Otherwise, malfunctions may cause serious accidents.
 - Most importantly, set up the following: an emergency stop circuit, a protection circuit, an interlock circuit for opposite movements (such as normal vs. reverse rotation), and an interlock circuit (to prevent damage to the equipment at the upper and lower positioning limits).
 - Note that when the CPU module detects an error, such as a watchdog timer error, during self-diagnosis, all outputs are turned off. Also, when an error that cannot be detected by the CPU module occurs in an input/output control block, output control may be disabled. External circuits and mechanisms should be designed to ensure safe machinery operation in such a case.
 - Note that the output current of the 24 V DC service power supply varies depending on the model and the absence/presence of extension modules. If an overload occurs, the voltage automatically drops, inputs in the PLC are disabled, and all outputs are turned off. External circuits and mechanisms should be designed to ensure safe machinery operation in such a case.
 - Note that when an error occurs in a relay, transistor or triac of an output circuit, the output might stay on or off. For output signals that may lead to serious accidents, external circuits and mechanisms should be designed to ensure safe machinery operation in such a case.
 - Construct an interlock circuit in the program so that the whole system always operates on the safe side before executing the control (for data change) of the PLC in operation.

Read the manual thoroughly and ensure complete safety before executing other controls (for program change, parameter change, forcible output and operation status change) of the PLC in operation. Otherwise, the machine may be damaged and accidents may occur due to erroneous operations.
 - In an output circuit, when a load current exceeding the current rating or an overcurrent caused by a load short-circuit flows for a long time, it may cause smoke and fire. To prevent this, configure an external safety circuit, such as a fuse.
 - For the operating status of each station after a communication failure of the network, refer to relevant manuals for the network. Incorrect output or malfunction may result in an accident.
-

[DESIGN PRECAUTIONS]

CAUTION

- When an inductive load such as a lamp, heater, or solenoid valve is controlled, a large current (approximately ten times greater than normal) may flow when the output is turned from off to on. Take proper measures so that the flowing current does not exceed the value corresponding to the maximum load specification of the resistance load.
 - After the CPU module is powered on or is reset, the time taken to enter the RUN status varies depending on the system configuration, parameter settings, and/or program size.
Design circuits so that the entire system will always operate safely, regardless of this variation in time.
 - Simultaneously turn on and off the power supplies of the CPU module and extension modules.
 - If a long-time power failure or an abnormal voltage drop occurs, the PLC stops, and output is turned off. When the power supply is restored, it will automatically restart (when the RUN/STOP/RESET switch is on the RUN side).
-

[SECURITY PRECAUTIONS]

WARNING

- To maintain the security (confidentiality, integrity, and availability) of the programmable controller and the system against unauthorized access, denial-of-service (DoS) attacks, computer viruses, and other cyberattacks from unreliable networks and devices via network, take appropriate measures such as firewalls, virtual private networks (VPNs), and antivirus solutions.
-

[INSTALLATION PRECAUTIONS]

WARNING

- Make sure to cut off all phases of the power supply externally before attempting installation or wiring work. Failure to do so may cause electric shock or damage to the product.
 - Use the product within the generic environment specifications described in the User's Manual (Hardware) of the CPU module used.
Never use the product in areas with excessive dust, oily smoke, conductive dusts, corrosive gas (salt air, Cl₂, H₂S, SO₂ or NO₂), flammable gas, vibration or impacts, or expose it to high temperature, condensation, or rain and wind.
If the product is used in such conditions, electric shock, fire, malfunctions, deterioration or damage may occur.
-

[INSTALLATION PRECAUTIONS]

CAUTION

- Do not touch the conductive parts of the product directly. Doing so may cause device failures or malfunctions.
 - When drilling screw holes or wiring, make sure that cutting and wiring debris do not enter the ventilation slits of the PLC. Failure to do so may cause fire, equipment failures or malfunctions.
 - For the product supplied together with a dust proof sheet, the sheet should be affixed to the ventilation slits before the installation and wiring work to prevent foreign objects such as cutting and wiring debris.
However, when the installation work is completed, make sure to remove the sheet to provide adequate ventilation. Failure to do so may cause fire, equipment failures or malfunctions.
 - Install the product on a flat surface. If the mounting surface is rough, undue force will be applied to the PC board, thereby causing nonconformities.
 - Install the product securely using a DIN rail or mounting screws.
 - Connect the expansion board and expansion adapter securely to their designated connectors. Loose connections may cause malfunctions.
 - Make sure to affix the expansion board with tapping screws. Tightening torque should follow the specifications in the manual. If the screws are tightened outside of the specified torque range, poor connections may cause malfunctions.
 - Work carefully when using a screwdriver such as installation of the product. Failure to do so may cause damage to the product or accidents.
 - Connect the extension cables, peripheral device cables, input/output cables and battery connecting cable securely to their designated connectors. Loose connections may cause malfunctions.
 - When using an SD memory card, insert it into the SD memory card slot. Check that it is inserted completely. Poor contact may cause malfunction.
 - Turn off the power to the PLC before attaching or detaching the following devices. Failure to do so may cause equipment failures or malfunctions.
 - Peripheral devices, expansion board, expansion adapter, and connector conversion adapter
 - Extension modules, bus conversion module, and connector conversion module
 - Battery
 - Hold the connector part of the Ethernet cable and perform installation or removal in a straight direction. If the cable is pulled out while connected to the module, it may cause damage to the module or the cable, or may cause a malfunction due to poor cable contact.
-

[WIRING PRECAUTIONS]

WARNING

- Make sure to cut off all phases of the power supply externally before attempting installation or wiring work. Failure to do so may cause electric shock or damage to the product.
 - Make sure to attach the terminal cover, provided as an accessory, before turning on the power or initiating operation after installation or wiring work. Failure to do so may cause electric shock.
 - The temperature rating of the cable should be 80°C or more.
It may differ depending on the extension devices. For details, refer to the user's manual of the extension devices.
 - Make sure to wire the screw terminal block in accordance with the following precautions. Failure to do so may cause electric shock, equipment failures, a short-circuit, wire breakage, malfunctions, or damage to the product.
 - The disposal size of the cable end should follow the dimensions described in the User's Manual (Hardware) of the CPU module used.
 - Tightening torque should follow the specifications in the User's Manual (Hardware) of the CPU module used.
 - Tighten the screws using a Phillips-head screwdriver No. 2 (shaft diameter 6 mm or less). Make sure that the screwdriver does not touch the partition part of the terminal block.
 - Make sure to properly wire to the terminal block (European type) in accordance with the following precautions. Failure to do so may cause electric shock, equipment failures, a short-circuit, wire breakage, malfunctions, or damage to the product.
 - The disposal size of the cable end should follow the dimensions described in the User's Manual (Hardware) of the CPU module used.
 - Tightening torque should follow the specifications in the User's Manual (Hardware) of the CPU module used.
 - Twist the ends of strand wire and make sure that there are no loose wires.
 - Do not solder-plate the electric wire ends.
 - Do not connect more than the specified number of wires or electric wires of unspecified size.
 - Affix the electric wires so that neither the terminal block nor the connected parts are directly stressed.
 - Make sure to properly wire to the spring clamp terminal block in accordance with the following precautions. Failure to do so may cause electric shock, equipment failures, a shortcircuit, wire breakage, malfunctions, or damage to the product.
 - The disposal size of the cable end should follow the dimensions described in the User's Manual (Hardware) of the CPU module used.
 - Twist the ends of stranded wires and make sure that there are no loose wires.
 - Do not solder-plate the electric wire ends.
 - Do not connect more than the specified number of wires or electric wires of unspecified size.
 - Affix the electric wires so that neither the terminal block nor the connected parts are directly stressed.
-

[WIRING PRECAUTIONS]

CAUTION

- Do not supply power to the [24+] and [24V] terminals (24 V DC service power supply) on the CPU module or extension modules. Doing so may cause damage to the product.
 - Perform class D grounding (grounding resistance: 100 Ω or less) of the grounding terminal on the CPU module and extension modules with a wire 2 mm² or thicker.
Do not use common grounding with heavy electrical systems (refer to the User's Manual (Hardware) of the CPU module used).
 - Connect the power supply to the dedicated terminals specified in the User's Manual (Hardware) of the CPU module used. If an AC power supply is connected to a DC input/output terminal or DC power supply terminal, the PLC will burn out.
 - Do not wire vacant terminals externally. Doing so may damage the product.
 - Install module so that excessive force will not be applied to terminal blocks, power connectors, I/O connectors, communication connectors, or communication cables. Failure to do so may result in wire damage/breakage or PLC failure.
 - Make sure to observe the following precautions in order to prevent any damage to the machinery or accidents due to malfunction of the PLC caused by abnormal data written to the PLC due to the effects of noise.
 - Do not bundle the power line, control line and communication cables together with or lay them close to the main circuit, high-voltage line, load line or power line. As a guideline, lay the power line, control line and communication cables at least 100 mm away from the main circuit, high-voltage line, load line or power line.
 - Ground the shield of the shield wire or shielded cable at one point on the PLC. However, do not use common grounding with heavy electrical systems.
-

[STARTUP AND MAINTENANCE PRECAUTIONS]

WARNING

- Do not touch any terminal while the PLC's power is on. Doing so may cause electric shock or malfunctions.
- Before cleaning or retightening terminals, cut off all phases of the power supply externally. Failure to do so in the power ON status may cause electric shock.
- Before modifying the program in operation, forcible output, running or stopping the PLC, read through this manual carefully, and ensure complete safety. An operation error may damage the machinery or cause accidents.
- Do not change the program in the PLC from two or more peripheral equipment devices at the same time. (i.e. from an engineering tool and a GOT) Doing so may cause destruction or malfunction of the PLC program.
- Use the battery for memory backup in conformance to the User's Manual (Hardware) of the CPU module used.
 - Use the battery for the specified purpose only.
 - Connect the battery correctly.
 - Do not charge, disassemble, heat, put in fire, short-circuit, connect reversely, weld, swallow or burn the battery, or apply excessive forces (vibration, impact, drop, etc.) to the battery.
 - Do not store or use the battery at high temperatures or expose to direct sunlight.
 - Do not expose to water, bring near fire or touch liquid leakage or other contents directly.
 - When replacing the battery, make sure to use our specified product (FX3U-32BL).
 - When a battery error occurs ("BAT" LED is lit in red), follow the description in the User's Manual (Hardware) of the CPU module used.

Incorrect handling of the battery may cause heat excessive generation, bursting, ignition, liquid leakage or deformation, and lead to injury, fire or failures and malfunction of facilities and other equipment.

[STARTUP AND MAINTENANCE PRECAUTIONS]

CAUTION

- Do not disassemble or modify the PLC. Doing so may cause fire, equipment failures, or malfunctions. For repair, contact your local Mitsubishi Electric representative.
 - After the first use of the SD memory card, do not insert/remove the memory card more than 500 times. 500 times or more may cause malfunction.
 - Turn off the power to the PLC before connecting or disconnecting any extension cable. Failure to do so may cause equipment failures or malfunctions.
 - Turn off the power to the PLC before attaching or detaching the following devices. Failure to do so may cause equipment failures or malfunctions.
 - Peripheral devices, expansion board, expansion adapter, and connector conversion adapter
 - Extension modules, bus conversion module, and connector conversion module
 - Battery
 - Do not use the chemicals for cleaning.
 - If there is the possibility of touching the PLC inside a control panel in maintenance, make sure to discharge to avoid the influence of static electricity.
 - Since there are risks such as burn injuries, please do not touch the surface of the equipment with bare hands when it is operating in an environment which exceeds ambient temperature of 50°C.
-

[OPERATION PRECAUTIONS]

CAUTION

- Construct an interlock circuit in the program so that the whole system always operates on the safe side before executing the control (for data change) of the PLC in operation. Read the manual thoroughly and ensure complete safety before executing other controls (for program change, parameter change, forcible output and operation status change) of the PLC in operation. Otherwise, the machine may be damaged and accidents may occur by erroneous operations.
-

[DISPOSAL PRECAUTIONS]

CAUTION

- Please contact a certified electronic waste disposal company for the environmentally safe recycling and disposal of your device.
 - When disposing of batteries, separate them from other waste according to local regulations. (For details of the Battery Directive in EU countries, refer to the User's Manual (Hardware) of the CPU module used.)
-

[TRANSPORTATION PRECAUTIONS]

CAUTION

- When transporting the PLC with the optional battery, turn on the PLC before shipment, confirm that the battery mode is set using a parameter and the BAT LED is OFF, and check the battery life. If the PLC is transported with the BAT LED ON or the battery exhausted, the battery-backed data may be unstable during transportation.
 - The PLC is a precision instrument. During transportation, avoid impacts larger than those specified in the general specifications of the User's Manual (Hardware) of the CPU module by using dedicated packaging boxes and shock-absorbing palettes. Failure to do so may cause failures in the PLC. After transportation, verify operation of the PLC and check for damage of the mounting part, etc.
 - When transporting lithium batteries, follow required transportation regulations. (For details on the regulated products, refer to the User's Manual (Hardware) of the CPU module used.)
 - When fumigants that contain halogen materials such as fluorine, chlorine, bromine, and iodine are used for disinfecting and protecting wooden packaging from insects, they cause malfunction when entering our products. Please take necessary precautions to ensure that remaining materials from fumigant do not enter our products, or treat packaging with methods other than fumigation (heat method). Additionally, disinfect and protect wood from insects before packing products.
-

INTRODUCTION

This manual contains text, diagrams and explanations which will guide the reader in the correct installation, safe use and operation of the FX5 Programmable Controllers and should be read and understood before attempting to install or use the module.

Always forward it to the end user.

Regarding use of this product

- This product has been manufactured as a general-purpose part for general industries, and has not been designed or manufactured to be incorporated in a device or system used in purposes related to human life.
- Before using the product for special purposes such as nuclear power, electric power, aerospace, medicine or passenger movement vehicles, consult Mitsubishi Electric.
- This product has been manufactured under strict quality control. However when installing the product where major accidents or losses could occur if the product fails, install appropriate backup or failsafe functions in the system.

Note

- If in doubt at any stage during the installation of the product, always consult a professional electrical engineer who is qualified and trained in the local and national standards. If in doubt about the operation or use, please consult the nearest Mitsubishi Electric representative.
- Since the examples indicated by this manual, technical bulletin, catalog, etc. are used as a reference, please use it after confirming the function and safety of the equipment and system. Mitsubishi Electric will accept no responsibility for actual use of the product based on these illustrative examples.
- This manual content, specification etc. may be changed without a notice for improvement.
- The information in this manual has been carefully checked and is believed to be accurate; however, if you notice a doubtful point, an error, etc., please contact the nearest Mitsubishi Electric representative. When doing so, please provide the manual number given at the end of this manual.

MEMO

CONTENTS

SAFETY PRECAUTIONS	1
INTRODUCTION	8
RELEVANT MANUALS	12
TERMS	13
CHAPTER 1 PART NAMES	16
1.1 FX5UJ CPU Module	16
Front panel	16
Side	18
1.2 FX5U CPU Module	19
Front panel	19
Side	21
1.3 FX5UC CPU Module	22
Front panel	22
Side	23
CHAPTER 2 SPECIFICATIONS	25
2.1 FX5UJ CPU module	25
Performance Specifications	25
Number of device points	26
2.2 FX5U/FX5UC CPU module	27
Performance Specifications	27
Number of device points	28
CHAPTER 3 FUNCTION LIST	29
CHAPTER 4 PROCEDURES BEFORE OPERATION	31
4.1 Installing a Battery	32
FX5U CPU module	32
FX5UC CPU module	33
4.2 Inserting and Removing an SD Memory Card	34
4.3 Creating a Project	36
4.4 Connecting a Personal Computer	37
When Ethernet cable is used (direct connection)	37
When Ethernet cable is used (connection via a hub)	38
When RS-232C cable is used	40
When USB cable is used (FX5UJ CPU module only)	41
4.5 Initializing the CPU Module	41
4.6 Setting Parameters	42
4.7 Programming	43
Registering labels	43
Inserting program elements	44
Inserting program elements by key input	46
4.8 Converting the Program	47
4.9 Saving the Project	47
4.10 Writing Data to the CPU Module	47
4.11 Resetting the CPU Module	48
4.12 Executing the Program	48

4.13	Monitoring the Program	49
4.14	Troubleshooting	50
	Troubleshooting procedure	50
	Checking with LEDs	51
	Troubleshooting using the engineering tool	52

APPENDIX **55**

Appendix 1	External Dimensions, Accessories	55
	FX5UJ CPU module	55
	FX5U CPU module	56
	FX5UC CPU module	57
Appendix 2	Added and Enhanced Functions	58

INDEX **60**

REVISIONS	62
WARRANTY	63
TRADEMARKS	64

RELEVANT MANUALS

Manual name <manual number>	Description
MELSEC iQ-F FX5 User's Manual (Startup) <JY997D58201> (This manual)	Describes the performance specifications, procedures before operation, and troubleshooting of the FX5 CPU module.
MELSEC iQ-F FX5UJ User's Manual (Hardware) <SH-082206ENG>	Describes the details of hardware of the FX5UJ CPU module, including input/output specifications, wiring, installation, and maintenance.
MELSEC iQ-F FX5U User's Manual (Hardware) <JY997D55301>	Describes the details of hardware of the FX5U CPU module, including input/output specifications, wiring, installation, and maintenance.
MELSEC iQ-F FX5UC User's Manual (Hardware) <JY997D61401>	Describes the details of hardware of the FX5UC CPU module, including input/output specifications, wiring, installation, and maintenance.
MELSEC iQ-F FX5 User's Manual (Application) <JY997D55401>	Describes the basic knowledge required for program design, functions of the CPU module, devices/labels, and parameters.
MELSEC iQ-F FX5 Programming Manual (Program Design) <JY997D55701>	Describes the specifications of ladder, ST, FBD/LD, and SFC programs, and labels.
MELSEC iQ-F FX5 Programming Manual (Instructions, Standard Functions/Function Blocks) <JY997D55801>	Describes the specifications of instructions and functions that can be used in programs.
MELSEC iQ-F FX5 User's Manual (Serial Communication) <JY997D55901>	Describes the N:N network, Parallel link, MELSEC Communication protocol, inverter communication, non-protocol communication, and predefined protocol support.
MELSEC iQ-F FX5 User's Manual (MELSEC Communication Protocol) <JY997D60801>	Explains methods for the device that is communicating with the CPU module by MC protocol to read and write the data of the CPU module.
MELSEC iQ-F FX5 User's Manual (MODBUS Communication) <JY997D56101>	Describes the MODBUS serial communication and MODBUS/TCP communication.
MELSEC iQ-F FX5 User's Manual (PROFIBUS) <SH-081910ENG>	Describes the PROFIBUS-DP master module.
MELSEC iQ-F FX5 User's Manual (Ethernet Communication) <JY997D56201>	Describes the Ethernet communication function of the CPU module built-in and the Ethernet module.
MELSEC iQ-F FX5-ENET User's Manual <SH-082026ENG>	Describes the FX5-ENET.
MELSEC iQ-F FX5-ENET/IP User's Manual <SH-082027ENG>	Describes the FX5-ENET/IP.
MELSEC iQ-F FX5 User's Manual (BACnet) <SH-082218ENG>	BACnet functions of the Ethernet module.
MELSEC iQ-F FX5 User's Manual (SLMP) <JY997D56001>	Explains methods for the device that is communicating with the CPU module by SLMP to read and write the data of the CPU module.
MELSEC iQ-F FX5 User's Manual (CC-Link IE TSN) <SH-082215ENG>	Describes the CC-Link IE TSN module.
MELSEC iQ-F FX5 User's Manual (CC-Link IE) <JY997D64201>	Describes the CC-Link IE field network module.
MELSEC iQ-F FX5 User's Manual (CC-Link) <SH-081793ENG>	Describes the CC-Link system master/intelligent device module.
MELSEC iQ-F FX5 User's Manual (AnyWireASLINK) <SH-081796ENG>	Describes the AnyWireASLINK system master module.
MELSEC iQ-F FX5 User's Manual (Positioning Control - CPU module built-in, High-speed pulse input/output module) <JY997D56301>	Describes the positioning function of the CPU module built-in and the high-speed pulse input/output module.
MELSEC iQ-F FX5 User's Manual (Positioning Control - Intelligent function module) <SH-081805ENG>	Describes the positioning module.
MELSEC iQ-F FX5 Motion Module/Simple Motion Module User's Manual (Startup) <IB0300251>	Describes the specifications, procedures before operation, system configuration, wiring, and operation examples of the Motion module/Simple Motion module.
MELSEC iQ-F FX5 Motion Module/Simple Motion Module User's Manual (Application) <IB0300253>	Describes the functions, input/output signals, buffer memories, parameter settings, programming, and troubleshooting of the Motion module/Simple Motion module.
MELSEC iQ-F FX5 Motion Module/Simple Motion Module User's Manual (Advanced Synchronous Control) <IB0300255>	Describes the functions and programming for the synchronous control of the Motion module/Simple Motion module.
MELSEC iQ-F FX5 Motion Module User's Manual (CC-Link IE TSN) <IB0300568>	Describes the functions, parameter settings, troubleshooting, and buffer memories of the CC-Link IE TSN network.

Manual name <manual number>	Description
MELSEC iQ-F FX5 User's Manual (Analog Control - CPU module built-in, Expansion adapter) <JY997D60501>	Describes the analog function of the CPU module built-in and the analog adapter.
MELSEC iQ-F FX5 User's Manual (Analog Control - Intelligent function module) <SH-081802ENG>	Describes the analog input module, analog output module, and multiple input module.
MELSEC iQ-F FX5 User's Manual (Temperature Control) <SH-081799ENG>	Describes the temperature control module.
MELSEC iQ-F FX5 User's Manual (Safety Control) <SH-082078ENG>	Describes the safety extension modules.
GX Works3 Operating Manual <SH-081215ENG>	Describes the system configuration, parameter settings, and online operations of GX Works3.
Transition from MELSEC FX3G, FX3U, FX3UC Series to MELSEC iQ-F Series Handbook <JY997D66201>	Describes the transition from MELSEC FX3G/FX3U/FX3UC series to MELSEC iQ-F series.

TERMS

Unless otherwise specified, this manual uses the following terms.

- □ indicates a variable part to collectively call multiple models or versions.

(Example) FX5U-32MR/ES, FX5U-32MT/ES ⇒ FX5U-32M□/ES

- For details on the FX3 devices that can be connected with the FX5, refer to the User's Manual (Hardware) of the CPU module to be used.

Terms	Description
■Devices	
FX5	Generic term for FX5UJ, FX5U and FX5UC PLCs
FX3	Generic term for FX3S, FX3G, FX3GC, FX3U, and FX3UC PLCs
FX5 CPU module	Generic term for FX5UJ CPU module, FX5U CPU module and FX5UC CPU module
FX5UJ CPU module	Generic term for FX5UJ-24MR/ES, FX5UJ-24MT/ES, FX5UJ-24MT/ESS, FX5UJ-40MR/ES, FX5UJ-40MT/ES, FX5UJ-40MT/ESS, FX5UJ-60MR/ES, FX5UJ-60MT/ES, and FX5UJ-60MT/ESS
FX5U CPU module	Generic term for FX5U-32MR/ES, FX5U-32MT/ES, FX5U-32MT/ESS, FX5U-64MR/ES, FX5U-64MT/ES, FX5U-64MT/ESS, FX5U-80MR/ES, FX5U-80MT/ES, FX5U-80MT/ESS, FX5U-32MR/DS, FX5U-32MT/DS, FX5U-32MT/DSS, FX5U-64MR/DS, FX5U-64MT/DS, FX5U-64MT/DSS, FX5U-80MR/DS, FX5U-80MT/DS, and FX5U-80MT/DSS
FX5UC CPU module	Generic term for FX5UC-32MT/D, FX5UC-32MT/DSS, FX5UC-64MT/D, FX5UC-64MT/DSS, FX5UC-96MT/D, FX5UC-96MT/DSS, FX5UC-32MT/DS-TS, FX5UC-32MT/DSS-TS, and FX5UC-32MR/DS-TS
Extension module	Generic term for FX5 extension modules, FX3 function modules, Extension modules (extension cable type) and Extension module (extension connector type)
FX5 extension module	Generic term for I/O modules, FX5 extension power supply modules, FX5 intelligent function modules, and FX5 safety extension modules
FX3 extension module	Generic term for FX3 extension power supply module and FX3 intelligent function module
Extension module (extension cable type)	Generic term for Input modules (extension cable type), Output modules (extension cable type), Input/output modules (extension cable type), Powered input/output module, High-speed pulse input/output module, Extension power supply module (extension cable type), Connector conversion module (extension cable type), Intelligent function modules, Safety extension modules, and Bus conversion module (extension cable type)
Extension module (extension connector type)	Generic term for Input modules (extension connector type), Output modules (extension connector type), Input/output modules (extension connector type), Extension power supply module (extension connector type), Connector conversion module (extension connector type), and Bus conversion module (extension connector type)
I/O module	Generic term for Input modules, Output modules, Input/output modules, Powered input/output modules, and High-speed pulse input/output modules
Input module	Generic term for Input modules (extension cable type) and Input modules (extension connector type)
Input module (extension cable type)	Generic term for FX5-8EX/ES and FX5-16EX/ES
Input module (extension connector type)	Generic term for FX5-C16EX/D, FX5-C16EX/DS, FX5-C32EX/D, FX5-C32EX/DS, and FX5-C32EX/DS-TS
Output module	Generic term for Output modules (extension cable type) and Output modules (extension connector type)
Output module (extension cable type)	Generic term for FX5-8EYR/ES, FX5-8EYT/ES, FX5-8EYT/ESS, FX5-16EYR/ES, FX5-16EYT/ES, and FX5-16EYT/ESS
Output module (extension connector type)	Generic term for FX5-C16EYT/D, FX5-C16EYT/DSS, FX5-C16EYR/D-TS, FX5-C32EYT/D, FX5-C32EYT/DSS, FX5-C32EYT/D-TS, and FX5-C32EYT/DSS-TS

Terms	Description
Input/output module	Generic term for Input/output modules (extension cable type) and Input/output modules (extension connector type)
Input/output module (extension cable type)	Generic term for FX5-16ER/ES, FX5-16ET/ES, and FX5-16ET/ESS
Input/output module (extension connector type)	Generic term for FX5-C32ET/D, FX5-C32ET/DSS, FX5-C32ET/DS-TS, and FX5-C32ET/DSS-TS
Powered input/output module	Generic term for FX5-32ER/ES, FX5-32ET/ES, FX5-32ET/ESS, FX5-32ER/DS, FX5-32ET/DS, and FX5-32ET/DSS
High-speed pulse input/output module	Generic term for FX5-16ET/ES-H and FX5-16ET/ESS-H
Extension power supply module	Generic term for FX5 extension power supply module and FX3 extension power supply module
FX5 extension power supply module	Generic term for FX5 extension power supply module (extension cable type) and FX5 extension power supply module (extension connector type)
FX5 extension power supply module (extension cable type)	Different name for FX5-1PSU-5V
FX5 extension power supply module (extension connector type)	Different name for FX5-C1PS-5V
FX3 extension power supply module	Different name for FX3U-1PSU-5V
Intelligent module	The abbreviation for intelligent function modules
Intelligent function module	Generic term for FX5 intelligent function modules and FX3 intelligent function modules
FX5 intelligent function module	Generic term for FX5-4AD, FX5-4DA, FX5-8AD, FX5-4LC, FX5-20PG-P, FX5-20PG-D, FX5-40SSC-G, FX5-80SSC-G, FX5-40SSC-S, FX5-80SSC-S, FX5-ENET, FX5-ENET/IP, FX5-CCLGN-MS, FX5-CCLIEF, FX5-CCL-MS, FX5-ASL-M, and FX5-DP-M
FX3 intelligent function module	Generic term for FX3U-4AD, FX3U-4DA, FX3U-4LC, FX3U-1PG, FX3U-2HC, FX3U-16CCL-M, FX3U-64CCL, FX3U-128ASL-M, and FX3U-32DP
FX5 safety extension module	Generic term for safety main modules and safety expansion modules
Safety main module	Different name for FX5-SF-MU4T5
Safety expansion module	Generic term for expansion modules installed to a safety main module
Safety input expansion module	Different name for FX5-SF-8DI4
Expansion board	Generic term for board for FX5UJ CPU module and FX5U CPU module
Communication board	Generic term for FX5-232-BD, FX5-485-BD, and FX5-422-BD-GOT
Expansion adapter	Generic term for adapter for FX5 CPU module
Communication adapter	Generic term for FX5-232ADP and FX5-485ADP
Analog adapter	Generic term for FX5-4AD-ADP, FX5-4DA-ADP, FX5-4AD-PT-ADP, FX5-4AD-TC-ADP, and FX5-4A-ADP
Bus conversion module	Generic term for Bus conversion module (extension cable type) and Bus conversion module (extension connector type)
Bus conversion module (extension cable type)	Different name for FX5-CNV-BUS
Bus conversion module (extension connector type)	Different name for FX5-CNV-BUSC
Connector conversion module	Generic term for Connector conversion module (extension cable type) and Connector conversion module (extension connector type)
Connector conversion module (extension cable type)	Different name for FX5-CNV-IF
Connector conversion module (extension connector type)	Different name for FX5-CNV-IFC
Extended extension cable	Generic term for FX5-30EC and FX5-65EC
Connector conversion adapter	Different name for FX5-CNV-BC
Battery	Different name for FX3U-32BL
SD memory card	Generic term for NZ1MEM-2GBSD, NZ1MEM-4GBSD, NZ1MEM-8GBSD, NZ1MEM-16GBSD, L1MEM-2GBSD and L1MEM-4GBSD SD memory cards Abbreviation of Secure Digital Memory Card. Device that stores data using flash memory.
Peripheral device	Generic term for engineering tools and GOTs
GOT	Generic term for Mitsubishi Electric Graphic Operation Terminal GOT1000 and GOT2000 series
■Software packages	
Engineering tool	The product name of the software package for the MELSEC programmable controllers
GX Works3	The product name of the software package, SWnDND-GXW3, for the MELSEC programmable controllers (The 'n' represents a version.)

Terms	Description
■Program relation	
FB instance	A function block that is inserted to a program
Global label	A label that is valid for all the program data when multiple program data are created in the project. There are two types of global label: a module specific label (module label), which is generated automatically by the engineering tool, and an optional label, which can be created for any specified device.
Device	A device (X, Y, M, D, or others) in a CPU module
POU	A unit that configures a program. Units are categorized and provided in accordance with functions. Use of POUs enables dividing the lower-layer processing in a hierarchical program into some units in accordance with processing or functions, and creating programs for each unit.
Program block	A group of POUs that configure a program
Module label	A label that represents one of memory areas (buffer memory areas) specific to each module in a given character string. For the module used, the engineering tool automatically generates this label, which can be used as a global label.
Label	A label that represents a device in a given character string

1 PART NAMES

This section describes the part names of the CPU module.

1.1 FX5UJ CPU Module

Front panel

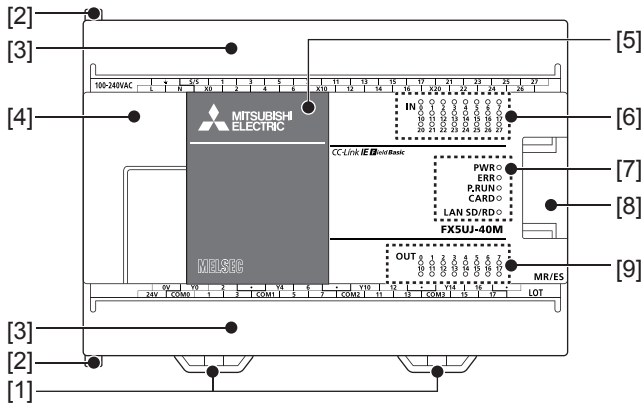

No.	Name	Description
[1]	DIN rail mounting hooks	Hook for mounting the CPU module on a DIN rail of DIN46277 (35 mm wide).
[2]	Expansion adapter connecting hooks	When connecting an expansion adapter, secure it with these hooks.
[3]	Terminal block cover	Cover for protecting the terminal block. The cover can be opened for wiring. Keep the covers closed while equipment is running (power is on).
[4]	Peripheral device connecting connector cover	Cover for protecting the SD memory card slot, the RUN/STOP/RESET switch, and others. The built-in USB communication connector, built-in Ethernet communication connector, RUN/STOP/RESET switch, SD memory card slot, and others are located under this cover.
[5]	Expansion board connector cover	Cover for protecting the expansion board connector.
[6]	Input display LED	Lit when input is on.
[7]	PWR LED	Indicates whether the CPU module is powered or not. Lit: Powered Off: Not powered or hardware error
	ERR LED	Indicates the error status of the CPU module. Lit: Error or hardware error Flashing: Factory default setting, error, hardware error, or resetting Off: Operating normally
	P.RUN LED	Indicates the program running status. Lit: Operating normally Flashing: Paused, Stopped (program mismatched), or online program change (PAUSE or RUN was set at the time of online program change.) Off: Stopped or stop error
	CARD LED	Indicates whether an SD memory card can be used or not. Lit: Can be used or cannot be removed. Flashing: In preparation Off: Not inserted or can be removed.
	SD/RD LED	Lit when the CPU module is sending or receiving data through built-in Ethernet communication.
[8]	Extension connector cover	Cover for protecting the extension connector. Connect the extension cable of an extension module to the extension connector under the cover.
[9]	Output display LED	Lit when output is on.

With cover open

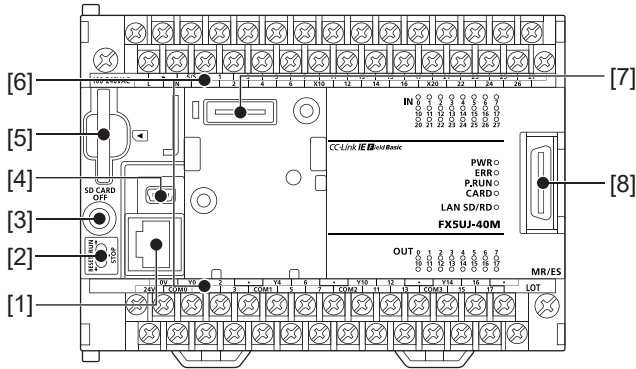

No.	Name	Description
[1]	Built-in Ethernet communication connector	Connector for connection with Ethernet-compatible devices. For details, refer to MELSEC iQ-F FX5 User's Manual (Ethernet Communication).
[2]	RUN/STOP/RESET switch	Switch for operating the CPU module. RUN: Runs the program STOP: Stops the program RESET: Resets the CPU module (hold the switch on the RESET side for approximately 1 second.)
[3]	SD memory card disable switch	Switch for disabling access to the SD memory card when the card is to be removed.
[4]	Built-in USB communication connector	Connector for connection with engineering tool.
[5]	SD memory card slot	Slot for inserting an SD memory card.
[6]	Terminal names	The signal names for power supply, input and output terminals are shown. ⏏ shows a function grounding terminal.
[7]	Expansion board connector	Connector for connecting an expansion board.
[8]	Extension connector	Connector for connecting the extension cable of an extension module.

When the terminal block covers are open

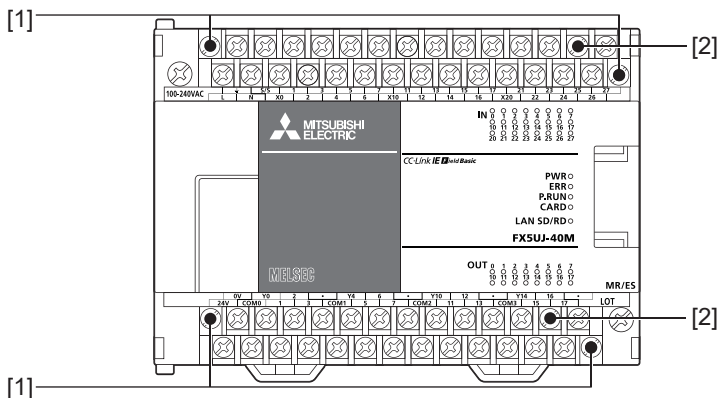

No.	Name	Description
[1]	Terminal block mounting screws	Gradually loosen the left and right screws (alternately), and remove the top of the terminal blocks.
[2]	Terminal	Terminals for power, input, and output. For details on the terminal layout, refer to MELSEC iQ-F FX5UJ User's Manual (Hardware).

Side

Left side/right side

Left side

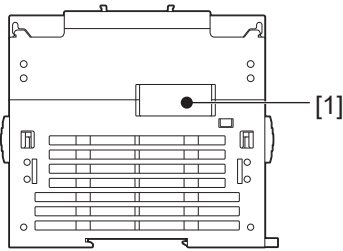

Right side

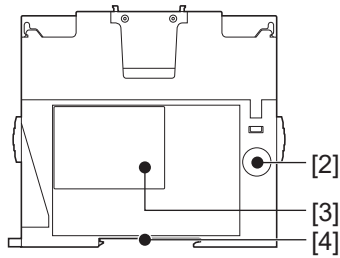

No.	Name	Description
[1]	Expansion adapter connector cover	Cover for protecting the expansion adapter connector. Connect the expansion adapter to the expansion adapter connector under the cover.
[2]	Genuine product certification label	Genuine product certification label to prevent counterfeiting
[3]	Nameplate	The product model name, Manufacturer's serial number, power supply specifications, and MAC address are shown.
[4]	DIN rail mounting groove	The module can be installed on DIN46277 rail (35 mm wide).

Point

Products that do not have the genuine product certification label or nameplate are not covered by the warranty.

Top side/bottom side

Top side

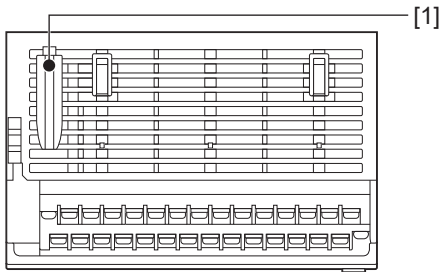

Bottom side

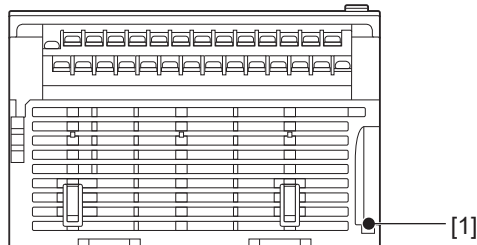

No.	Name	Description
[1]	CPU module fixing screw hole	Screw holes for fixing the CPU module to the panel.

1.2 FX5U CPU Module

Front panel

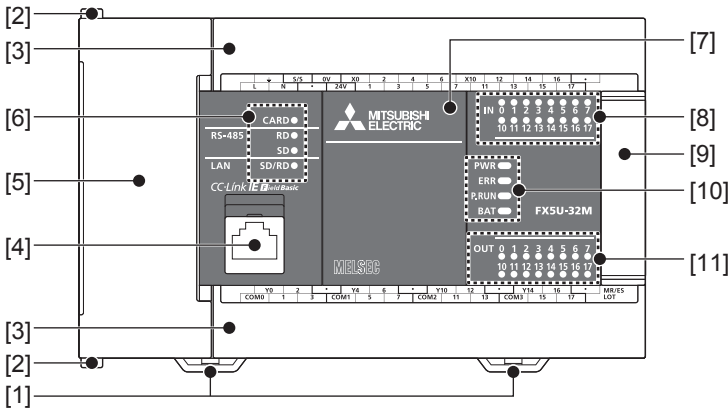

No.	Name	Description
[1]	DIN rail mounting hooks	Hook for mounting the CPU module on a DIN rail of DIN46277 (35 mm wide).
[2]	Expansion adapter connecting hooks	When connecting an expansion adapter, secure it with these hooks.
[3]	Terminal block cover	Cover for protecting the terminal block. The cover can be opened for wiring. Keep the covers closed while equipment is running (power is on).
[4]	Built-in Ethernet communication connector	Connector for connection with Ethernet-compatible devices. (with cap) For a connector which is not connected with the Ethernet cable, install a cap provided as an accessory in order to block dust or dirt. For details, refer to MELSEC iQ-F FX5 User's Manual (Ethernet Communication).
[5]	Top cover	Cover for protecting the SD memory card slot, the RUN/STOP/RESET switch, and others. The built-in RS-485 communication terminal block, built-in analog I/O terminal block, RUN/STOP/RESET switch, SD memory card slot, and others are located under this cover.
[6]	CARD LED	Indicates whether an SD memory card can be used or not. Lit: Can be used or cannot be removed. Flashing: In preparation Off: Not inserted or can be removed.
	RD LED	Lit when the CPU module is receiving data through built-in RS-485 communication.
	SD LED	Lit when the CPU module is sending data through built-in RS-485 communication.
	SD/RD LED	Lit when the CPU module is sending or receiving data through built-in Ethernet communication.
[7]	Expansion board connector cover	Cover for protecting expansion board connector, battery, or others. Connect the battery under this cover.
[8]	Input display LED	Lit when input is on.
[9]	Extension connector cover	Cover for protecting the extension connector. Connect the extension cable of an extension module to the extension connector under the cover.
[10]	PWR LED	Indicates whether the CPU module is powered or not. Lit: Powered Off: Not powered or hardware error
	ERR LED	Indicates the error status of the CPU module. Lit: Error or hardware error Flashing: Factory default setting, error, hardware error, or resetting Off: Operating normally
	P.RUN LED	Indicates the program running status. Lit: Operating normally Flashing: Paused, Stopped (program mismatched), or online program change (PAUSE or RUN was set at the time of online program change.) Off: Stopped or stop error
	BAT LED	Indicates the battery status. Flashing: Battery error Off: Operating normally
[11]	Output display LED	Lit when output is on.

With cover open

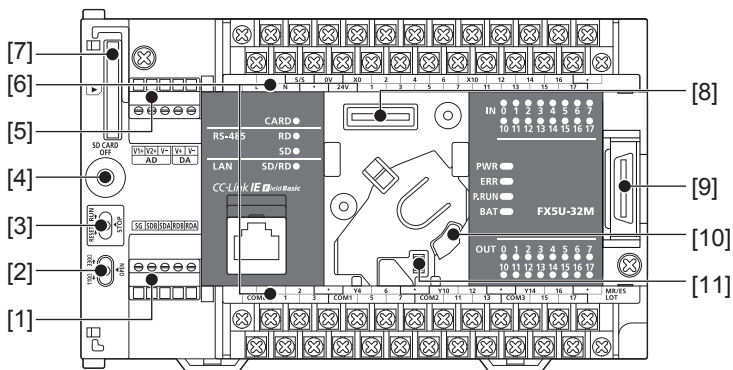

No.	Name	Description
[1]	Built-in RS-485 communication terminal block	Terminal block for connection with RS-485-compatible devices For details, refer to MELSEC iQ-F FX5U User's Manual (Hardware) .
[2]	RS-485 terminal resistor selector switch	Switch for switching terminal resistance for built-in RS-485 communication.
[3]	RUN/STOP/RESET switch	Switch for operating the CPU module. RUN: Runs the program STOP: Stops the program RESET: Resets the CPU module (hold the switch on the RESET side for approximately 1 second.)
[4]	SD memory card disable switch	Switch for disabling access to the SD memory card when the card is to be removed.
[5]	Built-in analog I/O terminal block	Terminal block for using the built-in analog function. For details, refer to MELSEC iQ-F FX5U User's Manual (Hardware) .
[6]	Terminal names	The signal names for power supply, input and output terminals are shown. shows a function grounding terminal.
[7]	SD memory card slot	Slot for inserting an SD memory card.
[8]	Expansion board connector	Connector for connecting an expansion board.
[9]	Extension connector	Connector for connecting the extension cable of an extension module.
[10]	Battery holder	Holder for storing an optional battery.
[11]	Battery connector	Connector for connecting an optional battery.

Point

Use a tool such as a screwdriver to operate RS-485 terminal resistor selector switch.
Make sure that the edge of the tool does not damage the switch or the case.

When the terminal block covers are open

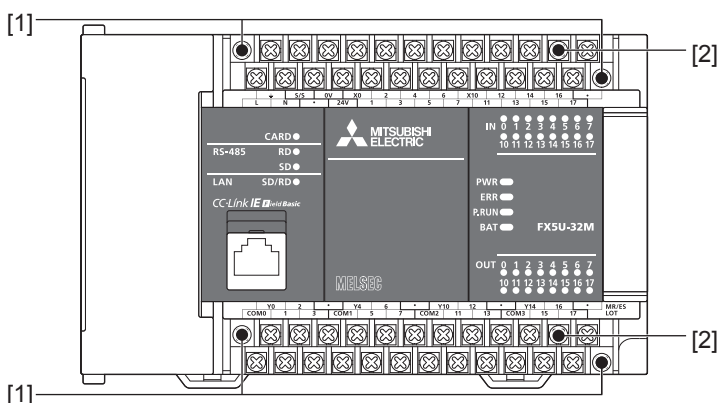

No.	Name	Description
[1]	Terminal block mounting screws	Gradually loosen the left and right screws (alternately), and remove the top of the terminal blocks.
[2]	Terminal	Terminals for power, input, and output. For details on the terminal layout, refer to MELSEC iQ-F FX5U User's Manual (Hardware) .

Side

Left side/Right side

Left side

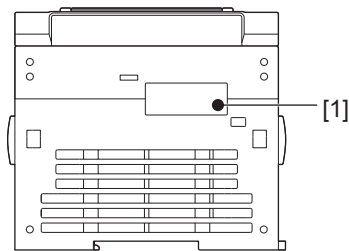

Right side

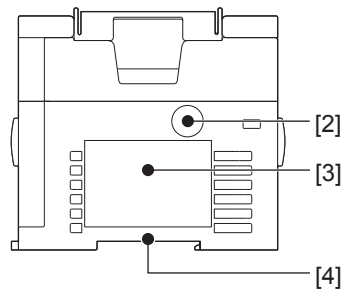

No.	Name	Description
[1]	Expansion adapter connector cover	Cover for protecting the expansion adapter connector. Connect the expansion adapter to the expansion adapter connector under the cover.
[2]	Genuine product certification label	Genuine product certification label to prevent counterfeiting
[3]	Nameplate	The product model name, Manufacturer's serial number, power supply specifications and MAC address are shown.
[4]	DIN rail mounting groove	The module can be installed on DIN46277 rail (35 mm wide).

Point

Products that do not have the genuine product certification label or nameplate and the nameplate are not covered by the warranty.

Top side/Bottom side

Top side

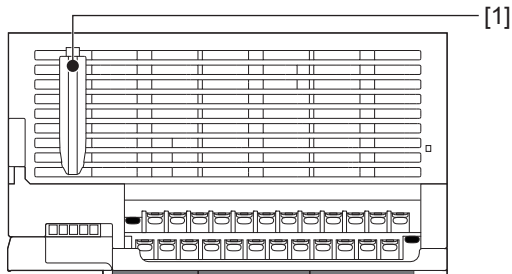

Bottom side

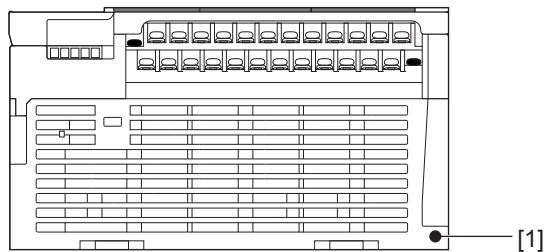

No.	Name	Description
[1]	CPU module fixing screw hole	Screw holes for fixing the CPU module to the panel. (In the case of FX5U-64M□/80M□, there are four screw holes.)

1.3 FX5UC CPU Module

Front panel

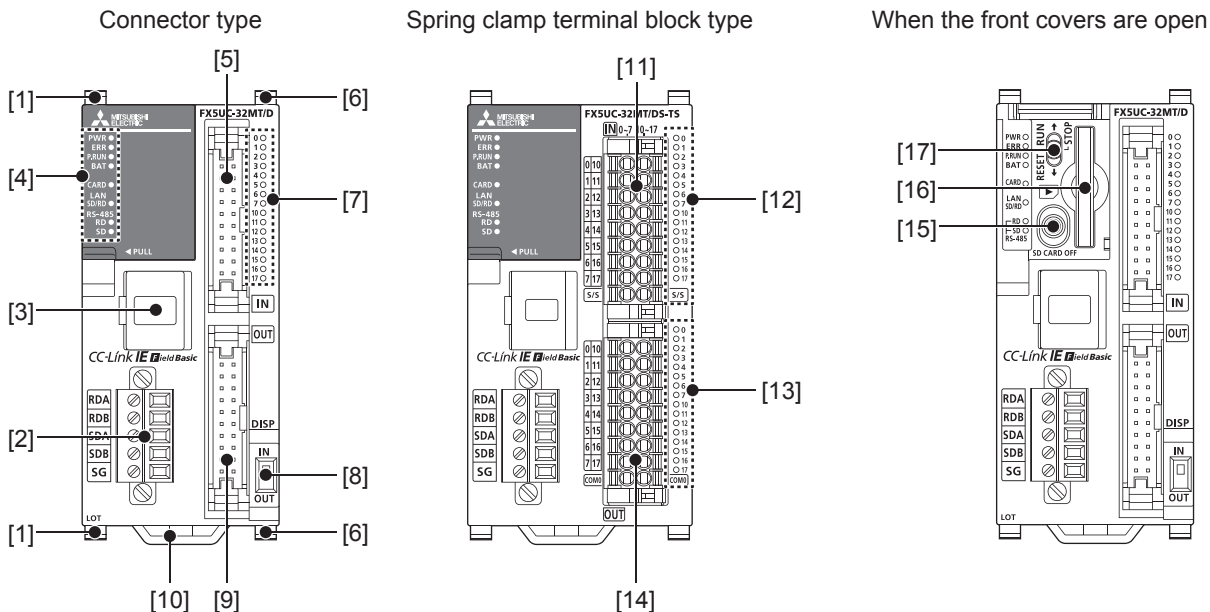

No.	Name	Description
[1]	Expansion adapter connecting hooks	When connecting an expansion adapter, secure it with these hooks.
[2]	Built-in RS-485 communication terminal block	Terminal block for connection with RS-485-compatible devices
[3]	Built-in Ethernet communication connector	Connector for connection with Ethernet-compatible devices (with cap) For a connector which is not connected with the Ethernet cable, install a cap provided as an accessory in order to block dust or dirt. For details, refer to MELSEC iQ-F FX5 User's Manual (Ethernet Communication).
[4]	Operation status display LED	
	PWR LED	Indicates whether the CPU module is powered or not. Lit: Powered Off: Not powered or hardware error
	ERR LED	Indicates the error status of the CPU module. Lit: Error or hardware error Flashing: Factory default setting, error, hardware error, or resetting Off: Operating normally
	P.RUN LED	Indicates the program running status. Lit: Operating normally Flashing: Paused, Stopped (program mismatched), or online program change (PAUSE or RUN was set at the time of online program change.) Off: Stopped or stop error
	BAT LED	Indicates the battery status. Flashing: Battery error Off: Operating normally
	CARD LED	Indicates whether an SD memory card can be used or not. Lit: Can be used or cannot be removed. Flashing: In preparation Off: Not inserted or can be removed.
	SD/RD LED	Lit when the CPU module is sending or receiving data through built-in Ethernet communication.
	RD LED	Lit when the CPU module is receiving data through built-in RS-485 communication.
	SD LED	Lit when the CPU module is sending data through built-in RS-485 communication.
[5]	Input connector	Connector for connecting input signal cables. For details on the terminal layout, refer to MELSEC iQ-F FX5UC User's Manual (Hardware).
[6]	Extension module connecting hook	When connecting an expansion module, secure it with these hooks.
[7]	I/O display LED	Lit when the input or output is on.

No.	Name	Description
[8]	DISP switch	Switches input/output of the I/O display LED.
[9]	Output connector	Connector for connecting output signal cables. For details on the terminal layout, refer to MELSEC iQ-F FX5UC User's Manual (Hardware).
[10]	DIN rail mounting hook	Hook for mounting a CPU module on a DIN rail of DIN46277 (35 mm wide).
[11]	Input terminal	Terminals for input. For details on the terminal layout, refer to MELSEC iQ-F FX5UC User's Manual (Hardware).
[12]	Input display LED	Lit when input is on.
[13]	Output display LED	Lit when output is on.
[14]	Output terminal	Terminals for output. For details on the terminal layout, refer to MELSEC iQ-F FX5UC User's Manual (Hardware).
[15]	SD memory card disable switch	Switch for disabling access to the SD memory card when the card is to be removed.
[16]	SD memory card slot	Slot for inserting an SD memory card.
[17]	RUN/STOP/RESET switch	Switch for operating the CPU module. RUN: Runs the program STOP: Stops the program RESET: Resets the CPU module (hold the switch on the RESET side for approximately 1 second.)

Side

Left side/right side

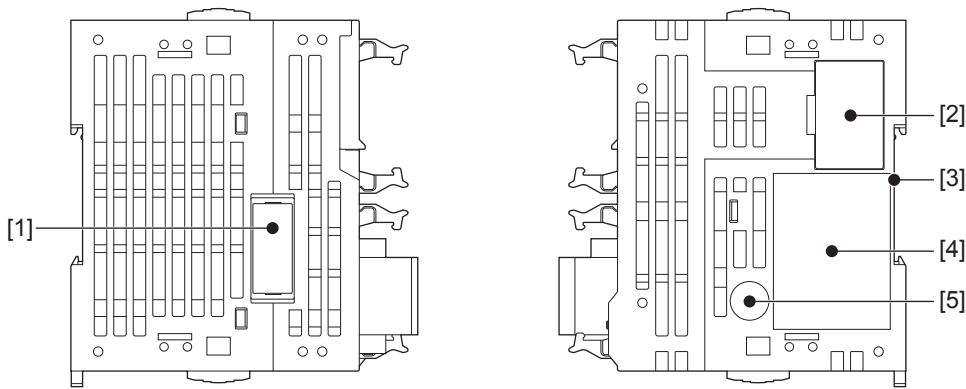



No.	Name	Description
[1]	Expansion adapter connector cover	Cover for protecting the expansion adapter connector.
[2]	Subsequent extension connector cover	Cover for protecting the subsequent extension connector.
[3]	DIN rail mounting groove	The module can be installed on a DIN46277 rail (35 mm wide).
[4]	Nameplate printing	The product model name, manufacturer's serial number, power supply specifications, and MAC address are shown. ⚠ is a mark that instructs to use the cable with an appropriate temperature rating (80°C or more) for wiring.
[5]	Genuine product certification label	Genuine product certification label to prevent counterfeiting

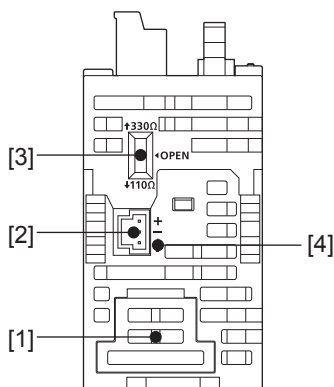

Products that do not have the genuine product certification label or nameplate are not covered by the warranty.

Bottom side



No.	Name	Description
[1]	Battery cover	Cover for protecting the battery connecting connector.
[2]	Power connector for CPU module	Connector for connecting power cables.
[3]	RS-485 terminal resistor selector switch	Switch for switching terminal resistance for built-in RS-485 communication.
[4]	Terminal names	 shows a function grounding terminal.

Point

Use a tool such as a screwdriver to operate the RS-485 terminal resistance selector switch. Make sure that the tip of a tool does not damage the switch or case.

2 SPECIFICATIONS

The CPU module performance specifications are explained below. For details on the other specifications, refer to the following manual.

📖 MELSEC iQ-F FX5UJ User's Manual (Hardware)

📖 MELSEC iQ-F FX5U User's Manual (Hardware)

📖 MELSEC iQ-F FX5UC User's Manual (Hardware)

2.1 FX5UJ CPU module

Performance Specifications

Item		Specification
Control system		Stored-program repetitive operation
Input/output control system		Refresh system (Direct access input/output allowed by specification of direct access input/output [DX, DY])
Programming specifications	Programming language	Ladder diagram (LD), structured text (ST), function block diagram/ladder diagram (FBD/LD)
	Programming extension function	Function block (FB), function (FUN), label programming (local/global)
	Constant scan	0.5 to 2000 ms (can be set in 0.1 ms increments)
	Fixed cycle interrupt	1 to 60000 ms (can be set in 1 ms increments)
	Timer performance specifications	100 ms, 10 ms, 1 ms
	No. of program executions	32
	No. of FB files	16 (Up to 15 for user)
Operation specifications	Execution type	Standby type, initial execution type, scan execution type, event execution type
	Interrupt type	Internal timer interrupt, input interruption, high-speed comparison match interrupt, interrupt by modules*1
Command processing time	LD X0	34 ns
	MOV D0 D1	34 ns
Memory capacity	Program capacity	48 k steps (96 kbytes, flash memory)
	SD memory card	Memory card capacity (SD/SDHC memory card: Max. 16 Gbytes)
	Device/label memory	120 kbytes
	Data memory/standard ROM	5 Mbytes
Flash memory (Flash ROM) write count		Maximum 20000 times
File storage capacity	Device/label memory	1
	Data memory P: No. of program files FB: No. of FB files	P: 32, FB: 16
	SD Memory Card	📖 MELSEC iQ-F FX5UJ User's Manual (Hardware)
Clock function	Display data	Year, month, day, hour, minute, second, day of week (leap year automatic detection)
	Precision	Differences per month ±45 sec./25°C (TYP)
Power failure retention (clock data*2)	Retention method	Large-capacity capacitor
	Retention time	15 days (Ambient temperature: 25°C)
No. of input/output points	(1) No. of input/output points	256 points or less
	(2) No. of remote I/O points	256 points or less
	Total No. of points of (1) and (2)	256 points or less
Power failure retention (device)	Power failure retention capacity	Maximum 12 k word

*1 Interrupt from the intelligent function module.

*2 Clock data is retained using the power accumulated in a large-capacity capacitor incorporated into the PLC. When voltage of the large-capacity capacitor drops, clock data is no longer accurately retained. The retention period of a fully charged capacitor (electricity is conducted across the PLC for at least 30 minutes) is 15 days (ambient temperature: 25°C). How long the capacitor can hold the data depends on the operating ambient temperature. When the operating ambient temperature is high, the holding period is short.



Number of device points

Item		Base	Max. number of points* ¹	
No. of user device points	Input relay (X)	8	1024 points	
	Output relay (Y)	8	1024 points	
	Internal relay (M)	10	7680 points	
	Latch relay (L)	10	7680 points	
	Link relay (B)	16	2048 points	
	Annunciator (F)	10	128 points	
	Link special relay (SB)	16	2048 points	
	Step relay (S)	10	4096 points	
	Timer system	Timer (T)	10	512 points
	Accumulation timer system	Accumulation timer (ST)	10	16 points
	Counter system	Counter (C)	10	256 points
		Long counter (LC)	10	64 points
	Data register (D)		10	8000 points
	Link register (W)		16	1024 points
	Link special register (SW)		16	1024 points
No. of system device points	Special relay (SM)	10	10000 points	
	Special register (SD)	10	12000 points	
Module access device	Intelligent function module device	10	Depends on the intelligent function module.	
No. of index register points	Index register (Z)	10	20 points	
	Long index register (LZ)	10	2 points	
No. of file register points	File register (R)	10	32768 points	
	Extended file register (ER)	10	32768 points (are stored in SD memory card)	
No. of nesting points	Nesting (N)	10	15 points	
No. of pointer points	Pointer (P)	10	2048 points	
	Interrupt pointer (I)	10	178 points	
Others	Decimal constant (K)	Signed	—	16 bits: -32768 to +32767, 32 bits: -2147483648 to +2147483647
		Unsigned	—	16 bits: 0 to 65535, 32 bits: 0 to 4294967295
	Hexadecimal constant (H)	—	16 bits: 0 to FFFF, 32 bits: 0 to FFFFFFFF	
	Real constant (E)	Single precision	—	E-3.40282347+38 to E-1.17549435-38, 0, E1.17549435-38 to E3.40282347+38
	Character string		—	Shift-JIS code max. 255 single-byte characters (256 including NULL)

*1 Maximum number of points cannot be changed. (fixed)

2.2 FX5U/FX5UC CPU module

Performance Specifications

Item		Specification
Control system		Stored-program repetitive operation
Input/output control system		Refresh system (Direct access input/output allowed by specification of direct access input/output [DX, DY])
Programming specifications	Programming language	Ladder diagram (LD), structured text (ST), function block diagram/ladder diagram (FBD/LD), sequential function chart (SFC) ^{*1}
	Programming extension function	Function block (FB), function (FUN), label programming (local/global)
	Constant scan	0.2 to 2000 ms (can be set in 0.1 ms increments)
	Fixed cycle interrupt	1 to 60000 ms (can be set in 1 ms increments)
	Timer performance specifications	100 ms, 10 ms, 1 ms
	No. of program executions	32
	No. of FB files	16 (Up to 15 for user)
Operation specifications	Execution type	Standby type, initial execution type, scan execution type, event execution type
	Interrupt type	Internal timer interrupt, input interruption, high-speed comparison match interrupt, interrupt by modules ^{*2}
Command processing time	LD X0	34 ns ^{*3}
	MOV D0 D1	34 ns ^{*3}
Memory capacity	Program capacity	64 k steps/128 k steps ^{*1} (128 kbytes/256 kbytes, flash memory)
	SD memory card	Memory card capacity (SD/SDHC memory card: Max. 16 Gbytes)
	Device/label memory	150 kbytes ^{*1}
	Data memory/standard ROM	5 Mbytes
Flash memory (Flash ROM) write count		Maximum 20000 times
File storage capacity	Device/label memory	1
	Data memory P: No. of program files FB: No. of FB files	P: 32, FB: 16
	SD memory card	 MELSEC iQ-F FX5U User's Manual (Hardware)  MELSEC iQ-F FX5UC User's Manual (Hardware)
Clock function	Display data	Year, month, day, hour, minute, second, day of week (leap year automatic detection)
	Precision	Differences per month ±45 sec./25°C (TYP)
Power failure retention (clock data ^{*4})	Retention method	Large-capacity capacitor
	Retention time	10 days (Ambient temperature: 25°C)
No. of input/output points	(1) No. of input/output points	256 points or less/384 points or less ^{*1}
	(2) No. of remote I/O points	384 points or less/512 points or less ^{*1}
	Total No. of points of (1) and (2)	512 points or less
Power failure retention (device)	Power failure retention capacity	Maximum 12 k word ^{*5}

*1 For supported versions, refer to  Page 58 Added and Enhanced Functions.

*2 Interruption from the intelligent function module and high-speed pulse input/output module.

*3 When the program capacity is 64 k steps.

*4 Clock data is retained using the power accumulated in a large-capacity capacitor incorporated into the PLC. When voltage of the large-capacity capacitor drops, clock data is no longer accurately retained. The retention period of a fully charged capacitor (electricity is conducted across the PLC for at least 30 minutes) is 10 days (ambient temperature: 25°C). How long the capacitor can hold the data depends on the operating ambient temperature. When the operating ambient temperature is high, the holding period is short.

*5 It is possible to back up all devices in device (high-speed) area. When a battery is used, it is also possible to back up devices in device (standard) area.

Number of device points

Item		Base	Max. number of points	
No. of user device points	Input relay (X)	8	1024 points	
	Output relay (Y)	8	1024 points	
	Internal relay (M)	10	32768 points (can be changed with parameter) ^{*2}	
	Latch relay (L)	10	32768 points (can be changed with parameter) ^{*2}	
	Link relay (B)	16	32768 points (can be changed with parameter) ^{*2}	
	Annunciator (F)	10	32768 points (can be changed with parameter) ^{*2}	
	Link special relay (SB)	16	32768 points (can be changed with parameter) ^{*2}	
	Step relay (S)	10	4096 points (fixed)	
	Timer system	Timer (T)	10	1024 points (can be changed with parameter) ^{*2}
	Accumulation timer system	Accumulation timer (ST)	10	1024 points (can be changed with parameter) ^{*2}
	Counter system	Counter (C)	10	1024 points (can be changed with parameter) ^{*2}
		Long counter (LC)	10	1024 points (can be changed with parameter) ^{*2}
	Data register (D)		10	8000 points (can be changed with parameter) ^{*2}
	Link register (W)		16	32768 points (can be changed with parameter) ^{*2}
	Link special register (SW)		16	32768 points (can be changed with parameter) ^{*2}
No. of system device points	Special relay (SM)	10	10000 points (fixed)	
	Special register (SD)	10	12000 points (fixed)	
Module access device	Intelligent function module device	10	65536 points (designated by U□\G□)	
No. of index register points	Index register (Z) ^{*3}	10	24 points	
	Long index register (LZ) ^{*3}	10	12 points	
No. of file register points	File register (R)	10	32768 points (can be changed with parameter) ^{*2}	
	Extended file register (ER)	10	32768 points (are stored in SD memory card)	
No. of nesting points	Nesting (N)	10	15 points (fixed)	
No. of pointer points	Pointer (P)	10	4096 points	
	Interrupt pointer (I)	10	178 points (fixed)	
No. of SFC points	SFC block device (BL)	10	32 points	
	SFC transition device (TR)	10	0 points (Used only as device comments.)	
Others	Decimal constant (K)	Signed	—	16 bits: -32768 to +32767, 32 bits: -2147483648 to +2147483647
		Unsigned	—	16 bits: 0 to 65535, 32 bits: 0 to 4294967295
	Hexadecimal constant (H)	—	16 bits: 0 to FFFF, 32 bits: 0 to FFFFFFFF	
	Real constant (E)	Single precision	—	E-3.40282347+38 to E-1.17549435-38, 0, E1.17549435-38 to E3.40282347+38
	Character string		—	Shift-JIS code max. 255 single-byte characters (256 including NULL) Unicode max. 255 characters (256 including NULL) ^{*1}

*1 For supported versions, refer to  Page 58 Added and Enhanced Functions.

*2 Can be changed with parameters within the capacity range of the CPU built-in memory.

*3 Total of the index register (Z) and long index register (LZ) is 24 words.

3 FUNCTION LIST

○: Supported, △: Limitedly supported, ×: Not supported

Function		Description	Function support	
			CPU module	
			FX5UJ	FX5U/ FX5UC
Firmware update function		This function updates the module's firmware using an SD memory card.	○	○
Scan monitoring function (Watchdog timer setting)		Detects an error in the hardware and program of the CPU module by monitoring the scan time.	○	○
Clock function		This function is used for the time management in the function which the system operates such as the date of the event history function, and data logging function.	○	○
Online change	Changing ladder blocks while online	Writes the part of a program edited on the ladder editor using the engineering tool to the CPU module in units of ladder blocks. Edited contents spanning multiple portions can be written to the CPU module at once.	○	○
Interrupt function	Multiple interrupt function	When an interrupt occurs while an interrupt program triggered by another cause is running, stops the program if its priority is lower than that of the new interrupt, and runs the higher-priority program whenever its execution condition is satisfied.	○	○
PID control function		Performs PID control by the PID control instruction.	○	○
Constant scan		Keeps the scan time constant and executes program repeatedly.	○	○
Remote operation	Remote RUN/STOP	Changes the CPU module status to the RUN/STOP/PAUSE status externally while the RUN/STOP/RESET switch of the CPU module is in RUN status.	○	○
	Remote PAUSE		○	○
	Remote RESET	Resets the CPU module externally while the CPU module is in the STOP status.	○	○
Device/label memory area setting		Sets the capacity of each area in the device/label memory.	×	○
Program capacity setting		Set to change program capacity.	×	○
Internal buffer capacity setting		Sets the capacity of the area (internal buffer) used by the system to temporarily store the results of data logging and memory dump processing.	○	○
Initial device value setting		Sets the initial values of devices used in the program directly (not via the program) to the devices.	○	○
Latch function		Holds the contents of the device and label of the CPU module when the power is turned ON etc.	○	○
Memory card function	SD memory card forced stop	Makes the SD memory card unavailable without turning OFF the power even when the function accessing the SD memory card is executed.	○	○
	Boot operation	Transfers the file stored in the SD memory card to the transfer destination memory judged automatically by the CPU module when the power is turned ON or is reset.	○	○
Device/label access service processing setting		Sets the number of execution times of the device/label access service processing executed by END processing, with parameter.	○	○
Data logging function		Collects data at the specified interval or any desired timing, and stores them as a file on the SD memory card.	○	○
Memory dump function		Saves the data in the devices of the CPU module at a desired timing.	○	○
Real-time monitor function		Monitors the data in the specified device of the CPU module at a specified interval or at a desired timing in real time.	○	○
RAS function	Self-diagnostics function	Self-diagnoses the CPU module to see whether an error exist or not.	○	○
	Error clear	Batch-clears all the continuation errors being detected.	○	○
	Event history function	Collects operations executed and errors detected from the modules, and saves them in the CPU module, expansion board, expansion adapter, and intelligent module. The saved logs can be checked in chronological order.	○	○
Data backup/restoration function		Backs up program files, parameter files, and device/label data files in a CPU module to an SD memory card. The backup data can be restored as needed.	○	○
Security function		Protects resources stored in PCs and resources in the units in the system of the FX5 from illegal access by a third party such as theft, alteration, accidental operation and unauthorized execution.	○	○
IP filter function		Identifies the IP address of external devices over Ethernet, and blocks access from an invalid IP address.	○	○

Function		Description	Function support	
			CPU module	
			FX5UJ	FX5U/ FX5UC
High-speed input/output function	High-speed counter function	Performs high-speed counter, pulse width measurement, input interruption, etc. by using the input of the CPU module or high-speed pulse input/output module.	△	○
	Pulse width measurement function			
	Input interrupt function			
	Positioning function	Executes positioning operation by using the transistor output of the CPU module or high-speed pulse input/output module.	△	○
	PWM output function	Executes a PWM output by using the transistor output of the CPU module or high-speed pulse input/output module.	△	○
Built-in analog function	Analog input function	Two analog inputs and one analog output are built in the FX5U CPU module so that voltage input/voltage output can be performed.	×	○*1
	Analog output function			
Built-in Ethernet function		An Ethernet related function such as connection to MELSOFT products and GOTs, socket communication, file transfer using FTP, Web server (HTTP), SNMP client, and simple CPU communication function.	△	○
CC-Link IE Field Network Basic function		This function exchanges data between the master station and slave station using general-purpose Ethernet.	○	○
Serial communication function		A function related to the serial communication such as N:N Network, parallel link, MC protocol, inverter communication function and non-protocol communication.	○	○
MODBUS communication function		Connection with the products which support MODBUS RTU/TCP is available. The master and slave functions can be used.	○	○
SFC function		Executes programs written in sequential function chart (SFC).	×	○

*1 Only FX5U CPU module is supported.

4 PROCEDURES BEFORE OPERATION

This chapter describes the procedures before operation.

1. Installing a battery (FX5U/FX5UC CPU module only)

Install a battery to the CPU module as needed. ( Page 32 Installing a Battery)

2. Inserting an SD memory card

Insert an SD memory card to the CPU module as needed. ( Page 34 Inserting and Removing an SD Memory Card)

3. Wiring of each device

Wire each device.

 MELSEC iQ-F FX5UJ User's Manual (Hardware)

 MELSEC iQ-F FX5U User's Manual (Hardware)

 MELSEC iQ-F FX5UC User's Manual (Hardware)

4. Powering on the system

Check the following items, and then power on the system.

- A cable is correctly connected to the power supply.
- Power supply voltage is within the specified range.
- The CPU module is in the STOP state.

5. Connecting a personal computer

Connect the CPU module to a personal computer that has an engineering tool installed. ( Page 37 Connecting a Personal Computer)

6. Initializing the CPU module

Initialize the CPU module using the engineering tool. ( Page 41 Initializing the CPU Module)

7. Setting parameters

Set system parameters, CPU parameters, and module parameters. ( Page 42 Setting Parameters)

When the following function of the CPU module are used, parameters of the function must be set.

- When the built-in Ethernet function is used
- When a function that uses SD memory card is used
- When any intelligent function module is mounted

8. Programming

Create a program using the engineering tool. ( Page 43 Programming)

9. Writing data to the programmable controller

Write the parameters and the program created by using the engineering tool to the programmable controller. ( Page 47 Writing Data to the CPU Module)

10. Resetting the CPU module

Restart the system in either of the following ways.

- Power off and on the system.
- Reset the CPU module. ( Page 48 Resetting the CPU Module)

11. Executing the program

Run the CPU module, and check that the P.RUN LED turns on. ( Page 48 Executing the Program)

12. Monitoring the program

Check that the program operates normally using the engineering tool. ( Page 49 Monitoring the Program)

Precautions

Do not write a program with more than 64 k steps to the FX5U/FX5UC CPU module firmware version earlier than 1.100. The program does not operate normally.

4.1 Installing a Battery

Install a battery to the CPU module as needed.

FX5U CPU module

Installation procedure

The battery is not included with the CPU module during shipment from the factory. To use the battery, attach it following the procedure below. Parameter setting is required to back up the device memory and clock data using the battery. (MELSEC iQ-F FX5U User's Manual (Hardware))

1. Turn the power supply off.
2. Remove the expansion board connector cover (A in figure below). If an expansion board is installed, remove it.

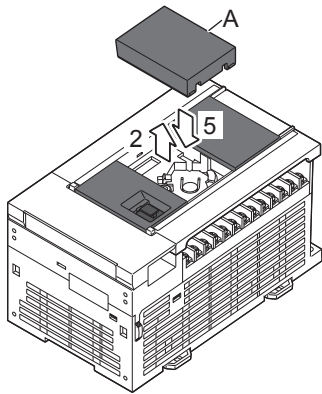

3. Insert the battery connector (B in the figure below) of the battery.
4. Set the battery inside the lower hook (C in the following figure), push up the upper hook (D in the following figure), and then fit the battery in the battery holder (E in the following figure).
The following figure shows the position of the battery.

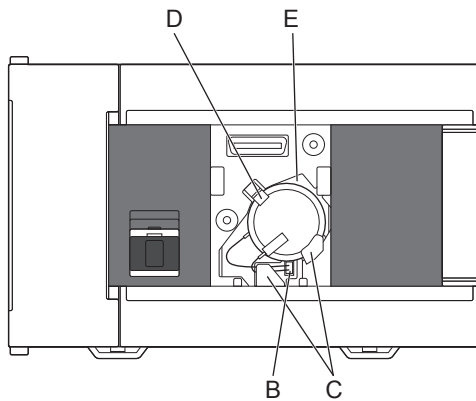

5. Attach the expansion board connector cover. If an expansion board was removed in step 2, reinstall it.

FX5UC CPU module

Attachment procedure

The battery is not incorporated in the CPU module at shipment from the factory. To use the battery, attach it following the procedure below. Proper parameter setting is required to back up the device memory and clock data using the battery.

( MELSEC iQ-F FX5UC User's Manual (Hardware))

1. Turn the power supply off.
2. Remove the battery cover (A in the figure below).

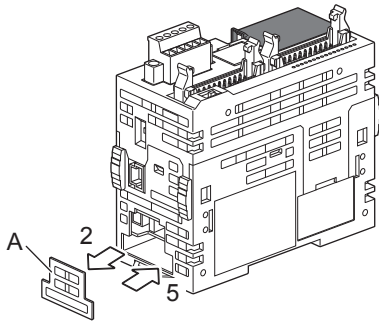

3. Push the battery into the battery holder (B in the figure below).
4. Insert the battery connector (C in the figure below) of the battery.

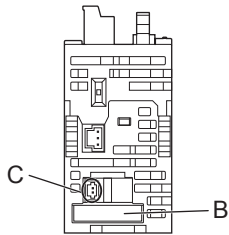

5. Attach the battery cover.

4.2 Inserting and Removing an SD Memory Card

The following explains insertion and removal of the SD memory card.

Insertion procedure

Mount the SD memory card. Pay attention to the direction of the card and follow the procedure below.

■FX5UJ CPU module

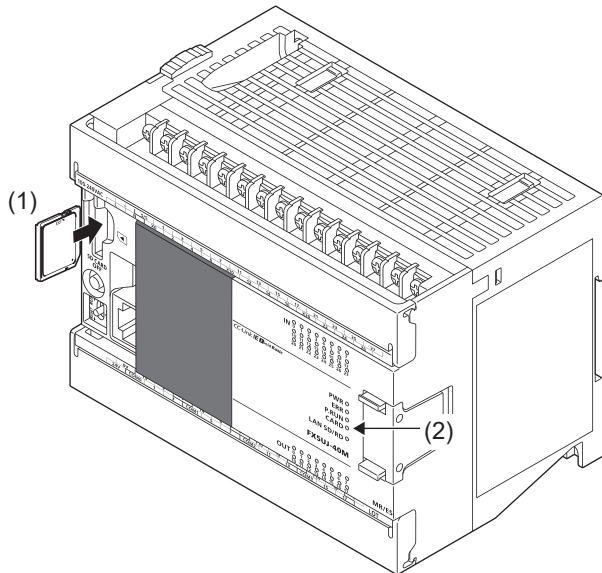

1. Insert the SD memory card (1) straight into the SD memory card slot. Make sure that the notch of the card is directed downward. After mounting, check that the card is mounted completely. If the card is mounted incompletely, malfunction may occur due to poor contact.
2. The CARD LED (2) blinks until the SD memory card becomes available.
3. The CARD LED turns on when the SD memory card is available.
4. If the CARD LED does not turn on even though the SD memory card is mounted, make sure that SM606 (memory card disable request) and SM607 (memory card disable status flag) are OFF by using engineering tools.

■FX5U CPU module

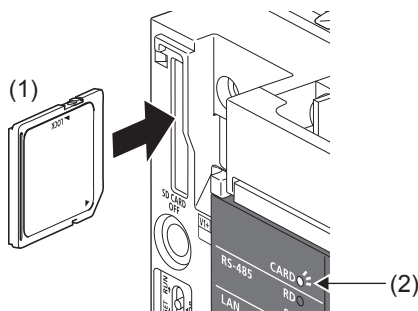

■FX5UC CPU module

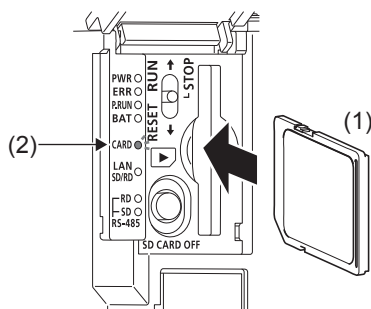

Removal procedure

■FX5UJ CPU module

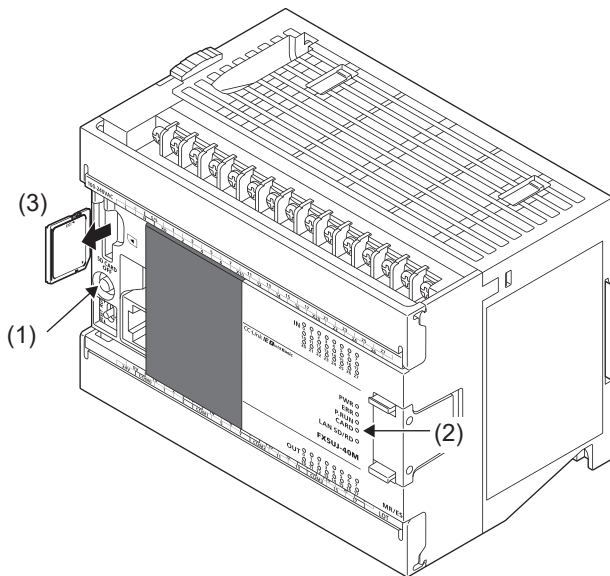

1. Press the SD memory card stop switch (1) for one second or more to stop access to the card. The CARD READY LED (2) blinks during the access stop operation, and then the LED is turned OFF when the operation is completed.
2. Insert the SD memory card (3) once, and then pull it straight out.

■FX5U CPU module

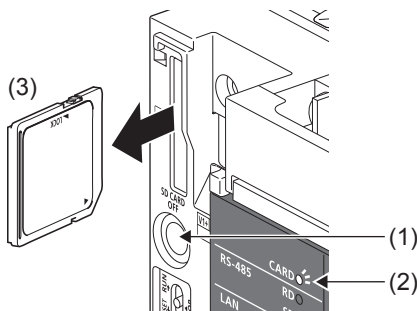

■FX5UC CPU module

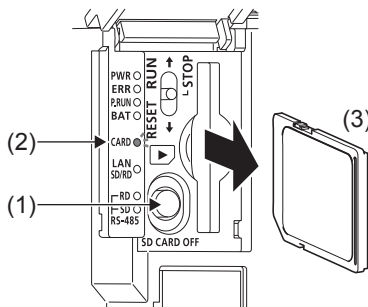

Precautions

- When mounting or removing the SD memory card while the power is ON, follow the above-mentioned procedure. Otherwise, the data in the card may become corrupted.
- When removing an SD memory card which is being accessed by a function, the CARD LED is turned OFF after the access is completed. When the CARD LED is turned OFF depends on the accessing function.
- When SM605 (memory card interchange protect flag) is ON, the CARD LED is not turned OFF even if the SD memory card stop switch is pressed. If the CARD LED is not turned OFF, turn ON SM606 (memory card disable request) so that the SD memory card cannot be used.

4.3 Creating a Project

Activate the engineering tool and create a project.

 [Project] ⇨ [New]

Procedure

Create a program, following the procedure below. This procedure is for programs described in ladder diagram.

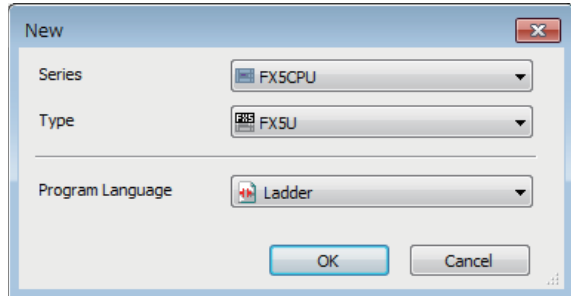

1. Select the model of the CPU module used. Then, specify a programming language used for the project. Select "Ladder", and click the [OK] button.

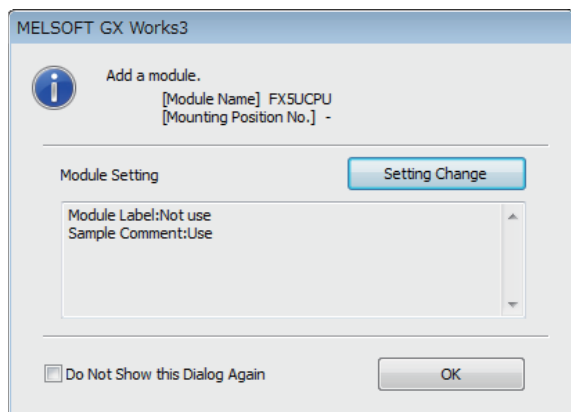

2. Click the [Setting Change] button when the window for adding module labels of the CPU module appears.

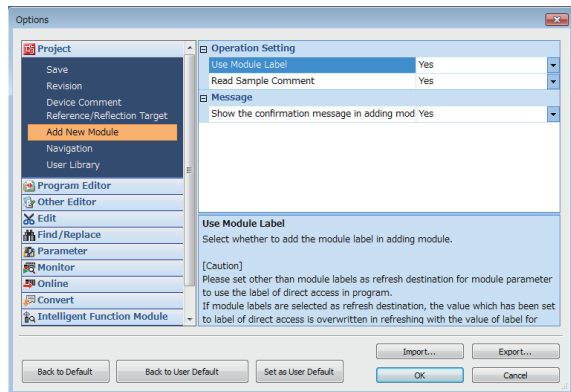

3. On the "Options" window, select [Yes] for [Use Module Label] and click the [OK] button.

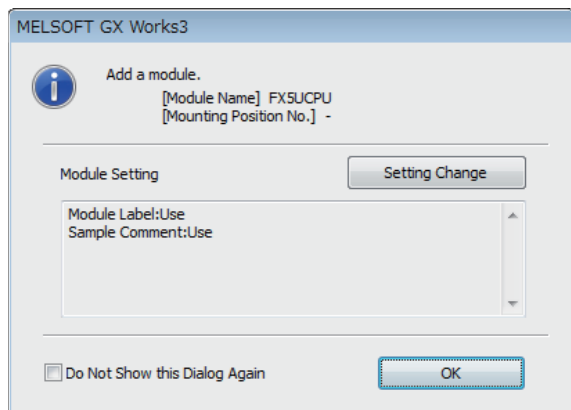

4. Click the [OK] button.

Module label is a label where the I/O signals and buffer memory areas of a module have already been defined. Use of module labels allows programming without being aware of module internal addresses.

4.4 Connecting a Personal Computer

Connect the CPU module to a personal computer that has an engineering tool installed.

For details on the system configuration examples and GX Works3 settings, refer to the following manual.

📖 MELSEC iQ-F FX5UJ User's Manual (Hardware)

📖 MELSEC iQ-F FX5U User's Manual (Hardware)

📖 MELSEC iQ-F FX5UC User's Manual (Hardware)

When Ethernet cable is used (direct connection)

Connect a personal computer directly to the CPU module, following the procedure below.

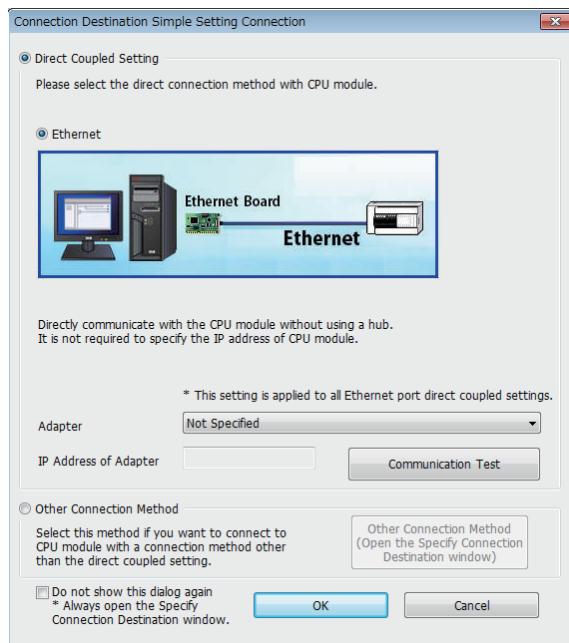

1. Connect a personal computer to the CPU module using the Ethernet cable.
2. Select [Online] ⇔ [Current Connection Destination] on the menubar of the engineering tool.
3. Select [Ethernet] as the direct connection method with the CPU module on the "Connection Destination Simple Setting Connection" window.
Click the [Communication Test] button to check if the connection can be established with the CPU module.

For the FX5 CPU module, the Ethernet adapter on the personal computer side used for the Ethernet port direct connection can be specified.

Select an adapter on the "Connection Destination Simple Setting Connection" window.

When Ethernet cable is used (connection via a hub)

To connect to Ethernet via a hub, setting of both the personal computer and the CPU module is required. Connect a personal computer to the CPU module via a hub, following the procedure below.

Setting the CPU module

■Setting module parameters

From the engineer tool, set on the “Module Parameter Ethernet Port” screen.

Select [Parameter] ⇒ [FX5UJCPU] or [FX5UCPU] ⇒ [Module Parameter] ⇒ [Ethernet Port] ⇒ [Basic Settings] ⇒ [Own Node Settings] on the Navigation window.

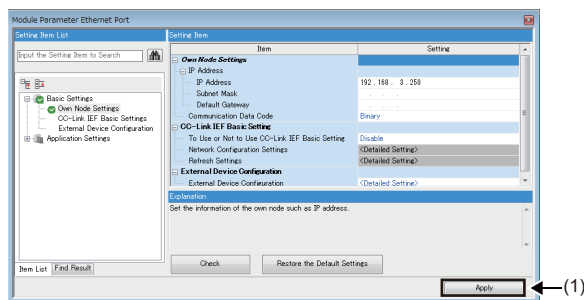

1. Set the IP address on the CPU module side and click the [Apply] button (1).

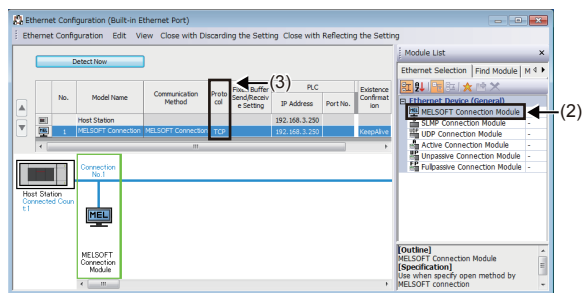

2. Setting for connection. Select [Basic Settings] ⇒ [External Device Configuration] ⇒ [Detailed Setting] ⇒ [Ethernet Configuration (Built-in Ethernet Port)] on the “Module Parameter Ethernet Port” screen.
3. Drag and drop "MELSOFT Connection Module" from the "Module List" to the left side of the screen. Select the protocol corresponding to the external device in “Protocol” (3).

■Writing to the CPU module

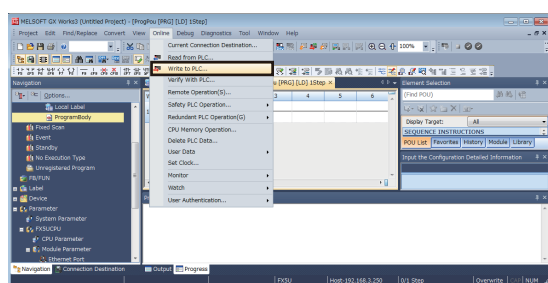

Write the parameters to be set in the CPU module.

Select [Online] ⇒ [Write to PLC] on the menu bar of the engineering tool.

After writing the parameters to the CPU module, power off and on or reset the CPU module to enable the parameters.

Engineering tool settings

From the engineer tool, this is done on the “Specify Connection Destination Connection” window.

Select “Online” ⇒ [Current Connection Destination] .

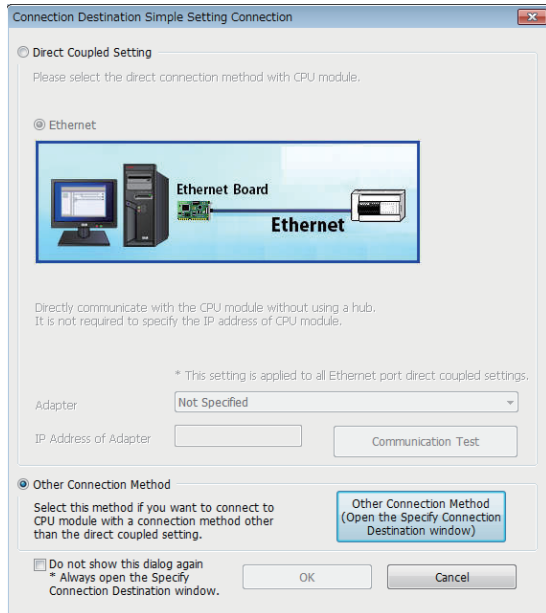

1. On the "Connection Destination Simple Setting Connection" window, select another connection method by clicking the [Other Connection Method (Open the Specify Connection Destination Window)] button.

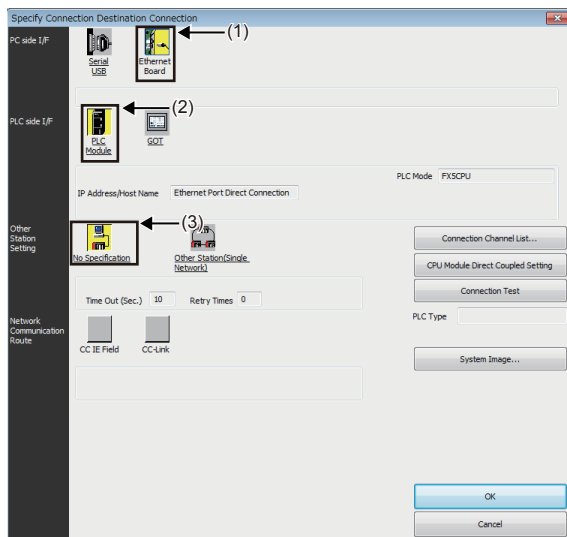

2. Select "Ethernet Board" for "PC side I/F"(1).
3. Select "PLC Module" for "PLC side I/F"(2).

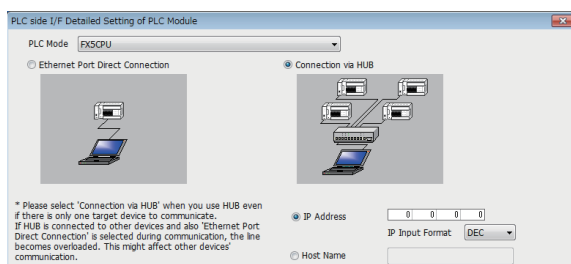

Input the CPU IP address or host name in the “PLC side I/F Detailed Setting of PLC Module” screen as shown in the left figure.

In case of host name, set the name specified in the Microsoft® Windows® hosts file.

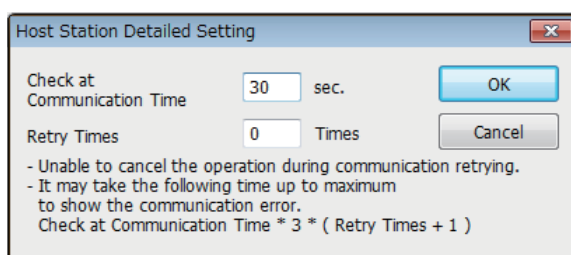

4. Double-click "No Specification" (3) on the "Specify Connection Destination Connection" window to set "Other Station Setting". Select an item appropriate to the operating environment.

Connection of the Ethernet cable

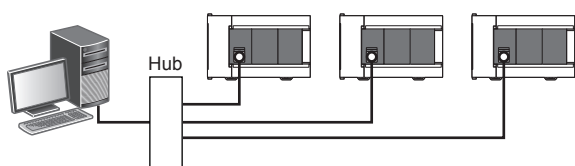

1. Connect a personal computer to the CPU module via a hub.

Point

Use the [Find] button in the "PLC side I/F Detailed Setting of PLC Module". The IP address of the connected CPU module can be searched and can be set to "IP Address".

When RS-232C cable is used

Connect a personal computer directly to the CPU module, following the procedure below.

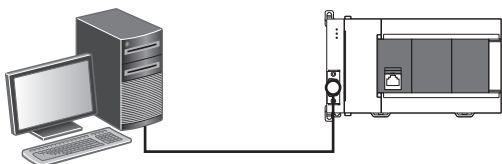

1. Connect a personal computer to the CPU module using the RS-232C cable.*¹
2. Select [Online] ⇒ [Current Connection Destination] on the menubar of the engineering tool.
3. On the "Connection Destination Simple Setting Connection" window, select another connection method by clicking the [Other Connection Method (Open the Specify Connection Destination Window)] button.

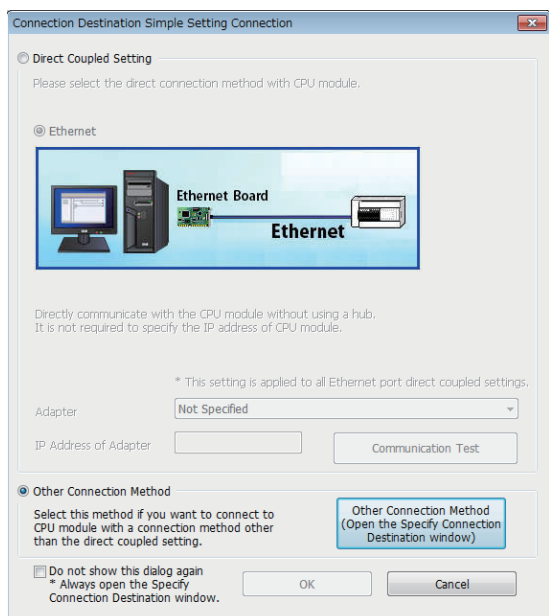

4. Click the [CPU Module Direct Coupled Setting] button (1) on the "Specify Connection Destination Connection" window.

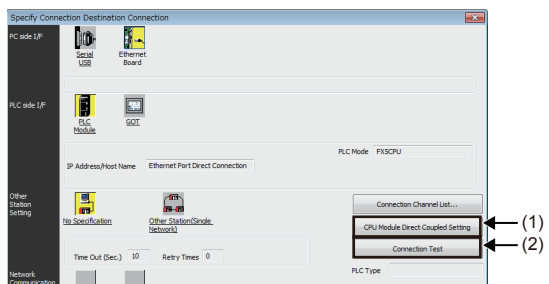

5. Select [RS-232C] for the connection method, and click the [Yes] button.
6. Click the [Connection Test] button (2), and check if the personal computer is connected to the CPU module.

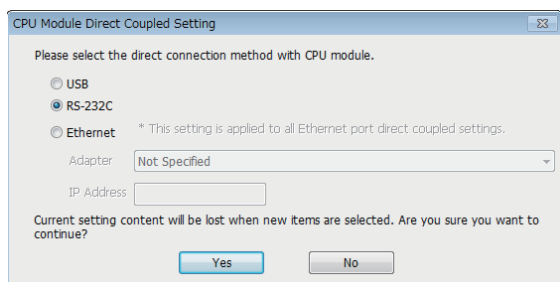

*1 When connecting by RS-232C cable, an expansion board or expansion adapter is required.

When USB cable is used (FX5UJ CPU module only)

Connect a personal computer directly to the CPU module, following the procedure below.

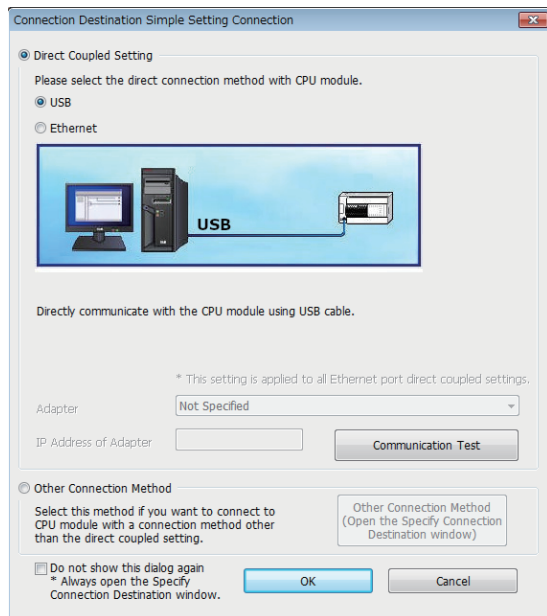

1. Connect a personal computer to the CPU module using the USB cable.
2. Select [Online] ⇒ [Current Connection Destination] on the menubar of the engineering tool.
3. Select "USB" as the direct connection method with the CPU module on the "Connection Destination Simple Setting Connection" window.
Click the "Communication Test" button to check if the connection can be established with the CPU module.

4

Point

- When a personal computer and CPU module are connected, the driver is automatically installed. If the driver is not installed, install it manually. (GX Works3 Operating Manual)
- When a personal computer and CPU module are connected, a message prompting you to start GX Works3 is displayed. (a message is not displayed when GX Works3 starts.)

4.5 Initializing the CPU Module

Initialize the CPU module.

[Online] ⇒ [CPU Memory Operation]

Procedure

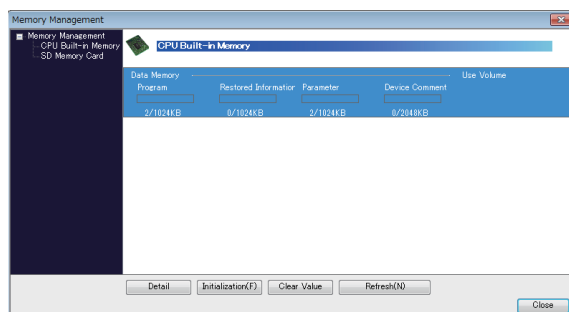

1. Select "Data Memory" on the "Memory Management" window, and click the [Initialization] button.
2. After the initialization processing completes, click the [Close] button.

4.6 Setting Parameters

Set system parameters and parameters for each module.

When setting parameters from the Navigation window

The following shows how to set parameters.

■System parameters

These parameters need to be set from the Navigation window in the following cases: to change the Model Name, and to set CPU Module Operation Setting at Error Detection.

🖱️ "Navigation window" ⇒ "Parameter" ⇒ "System Parameter"

■CPU Parameter

CPU module requires setting of CPU Parameter.

🖱️ "Navigation window" ⇒ "Parameter" ⇒ "FX5UJCPU" or "FX5UCPU" ⇒ "CPU Parameter"

■Module parameters of the CPU module

These parameters are required to execute each built-in function of the CPU module.

🖱️ "Navigation window" ⇒ "Parameter" ⇒ "FX5UJCPU" or "FX5UCPU" ⇒ "Module Parameter"

■Memory card parameters

These parameters are required to execute functions that access the SD memory card.

🖱️ "Navigation window" ⇒ "Parameter" ⇒ "FX5UJCPU" or "FX5UCPU" ⇒ "Memory Card Parameter"

■Module Parameter (Each expansion adapter or intelligent function module)

Expansion Adapter and Intelligent Function Module requires setting of Module Parameter.

🖱️ "Navigation window" ⇒ "Parameter" ⇒ "Module Information" ⇒ (each expansion adapter or intelligent function module) ⇒ "Module Parameter"

When setting parameters from the Module configuration diagram

"CPU parameter" and "module parameter" can be set from the module configuration diagram. The following shows how to set them.

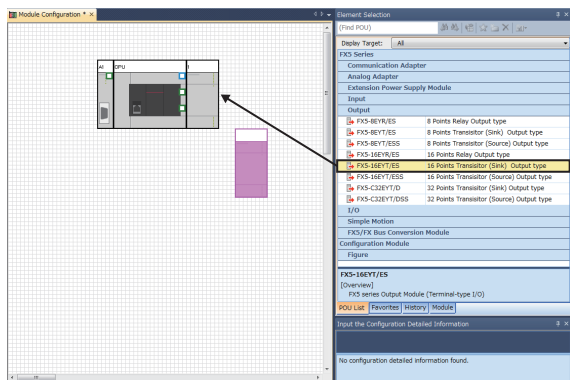

1. Drag each module to be used from the parts select window to the module configuration diagram with the mouse, and place the module to be coupled to the CPU module on the diagram.
2. Select [Edit] ⇒ [Parameter] ⇒ [Fix] on the menu bar.
3. When module labels are prepared in the configured modules, the window for adding module labels appears. Click the [Yes] button.
4. Open the parameter editor of each module by double-clicking the module having parameters that can be set.
5. Set parameters, and click the [Apply] button to close the window.

4.7 Programming

Create a program. This section describes how to create a program using the following program example.

Program example

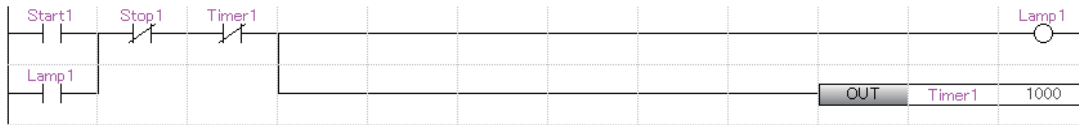

- When Start1 turns on, Timer1 starts counting, and Lamp1 turns on.
- When the current value of Timer1 reaches 1000, Lamp1 turns off.
- When Stop1 turns on, Lamp1 turns off.

Registering labels

Label is a variable whose name and data type can be declared by a user.

Use of labels allows programming without concern to devices and buffer memory addresses. For this reason, programs using labels can be used in other systems where the module configuration is different.

Labels can be registered on the label editor.

"Navigation window" ⇒ "Program" ⇒ "Scan" ⇒ "MAIN" ⇒ "ProgPou" ⇒ "Local Label"

Procedure

Register the label "Start1" in the program example, following the procedure below.



1. Enter the name, "Start1", in the "Label Name" field (1).
2. Click the button (2) on the right of the "Data Type" field to open the "Data Type Selection" window.
3. Specify the data type. Select "Bit", and click the [OK] button.

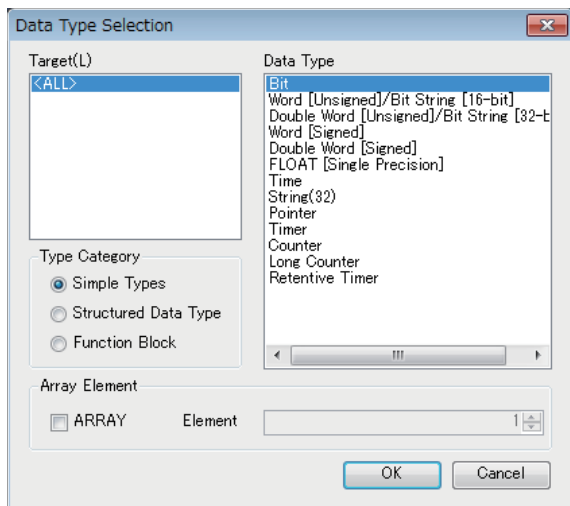

Register other labels in the program example in the same way.

Point

- The class, and constant of labels can be set as needed by clicking the [Show Details] button on the label editor.
- Labels can also be registered while programming without opening the label editor. (☞ Page 46 Inserting program elements by key input)
- Devices can be assigned to global labels. Open the global label editor, and enter a device in the "Assign (Device/Label)" field.

Inserting program elements

Drag and drop required program elements to the ladder editor.

"Navigation window" ⇒ "Program" ⇒ "Scan" ⇒ "MAIN" ⇒ "ProgPou" ⇒ "Program"

Procedure

Insert a normally open contact of "Start1" in the program example, following the procedure below.

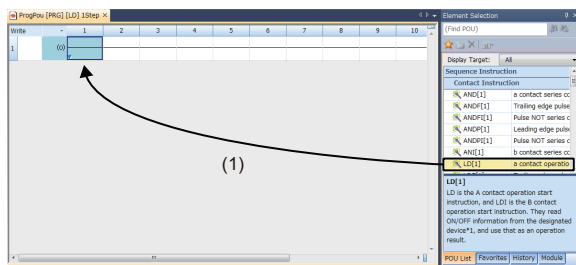

1. Select a program element from the Element Selection window, and drag and drop (1) it to the desired position in the ladder editor. In this example, drag and drop "LD[1]".

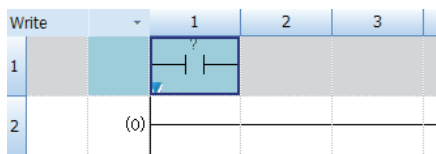

2. Double-click the inserted program element to open the ladder entry window, and click the [ExtD Dspl] button.

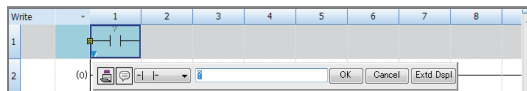

3. Specify the operand. In this example, enter "Start" for "s" in the "Device/Label" field (2).

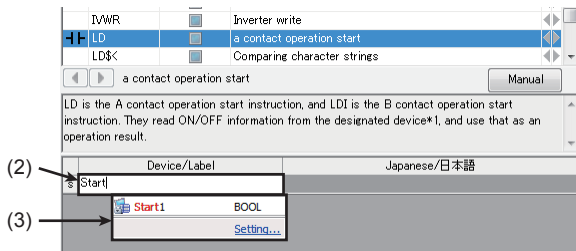

4. Select an item from the displayed list (3). In this example, select "Start1".

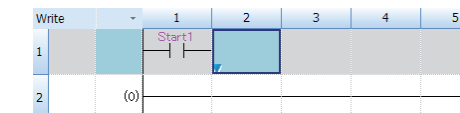

5. The normally open contact of "Start1" is inserted to the program.

Insert other program elements in the program example in the same way.

Point

Common instructions, such as contacts and coils, standard functions/function blocks, and user-defined function blocks/functions can be found in the [POU List] (1) in the Element Selection window. Narrow down the list using the drop-down menu (2) for "Display Target" and making a selection.

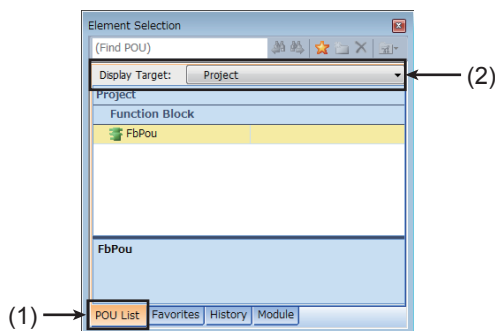

■ Inserting function blocks

Insert function blocks, following the procedure below.

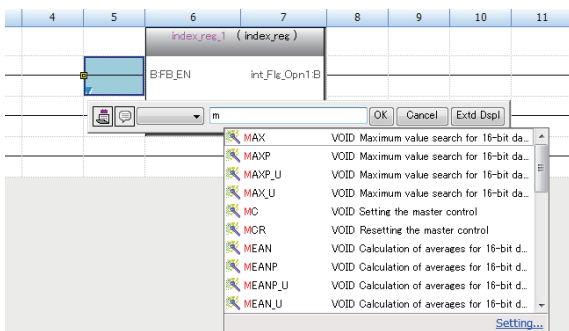
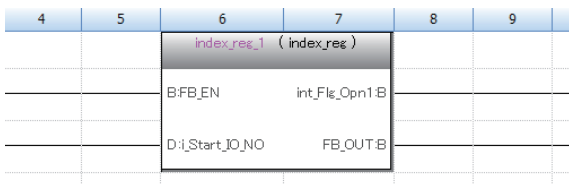
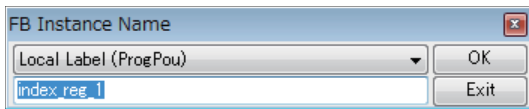
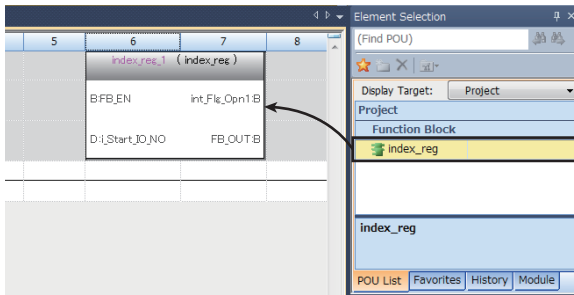

1. Select a function block from the Element Selection window, and drag and drop it to the desired position on the ladder editor.
2. The "FB Instance Name" window opens. Select the target label (global label or local label), and enter an instance name.
3. Select [Convert] ⇨ [Convert] on the menu bar. The ladder is converted, and the rungs are connected to the input and output labels of the FB instance.
4. Add the input and output parts of the inserted function block to complete the program.

4

■ Creating function blocks/functions

User-defined function blocks/functions must be created before inserted to the program.

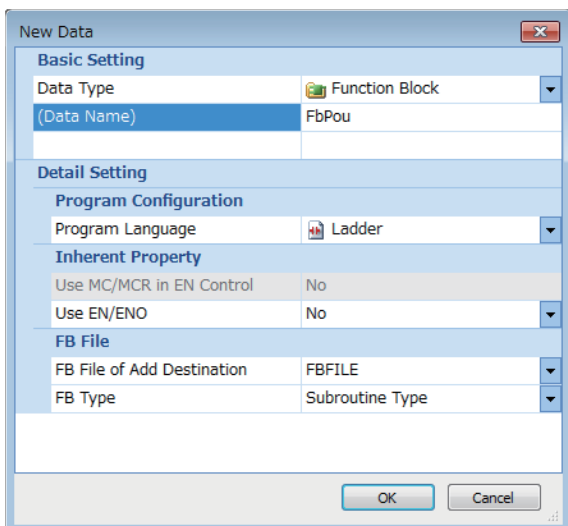
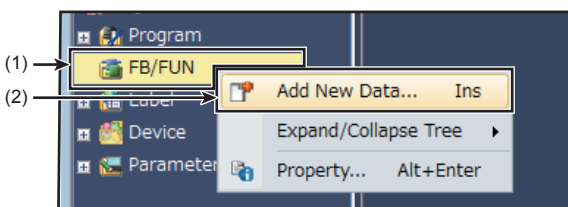

1. Right-click "FB/FUN" (1) on the Navigation window, and select "Add New Data" (2) to open the setting window.
2. To create a function block, set the data type to "Function Block" using the drop-down list. To create a function, set the data type to "Function". Then, click the [OK] button.
3. Create the processing of the function block or function on the "Program" window.

Inserting program elements by key input

Program elements can be inserted by key input.

Procedure

Inserting a normally open contact of "Start1" in the program example, following the procedure below.

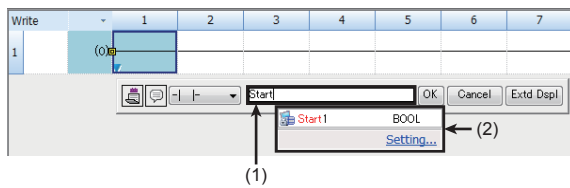

1. Click the insertion position on the ladder editor, and press **[F5]**.
2. Enter the name, "Start", in the entry field (1). Select "Start1" from the displayed list (2).
3. The normally open contact of "Start1" is inserted to the program.

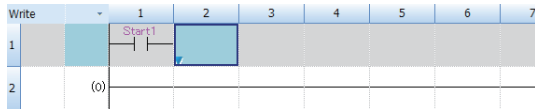

Point

A new label can be registered during insertion. Enter the name of a new label on the ladder entry window, and click the [OK] button. Then, specify the registered destination, class, and data type of the label on the "Undefined Label Registration" window, and click the [OK] button.



4.8 Converting the Program

Compile the input ladder blocks.

Procedure

1. Select [Convert] ⇒ [Convert] on the menu bar.
2. When the conversion processing completes and the input ladder blocks are compiled, the color of those ladder blocks changes from gray to white.

4.9 Saving the Project

Save the created project.

 [Project] ⇒ [Save as]

4.10 Writing Data to the CPU Module

Write the set parameters and the created program to the CPU module.

 [Online] ⇒ [Write to PLC]

Procedure

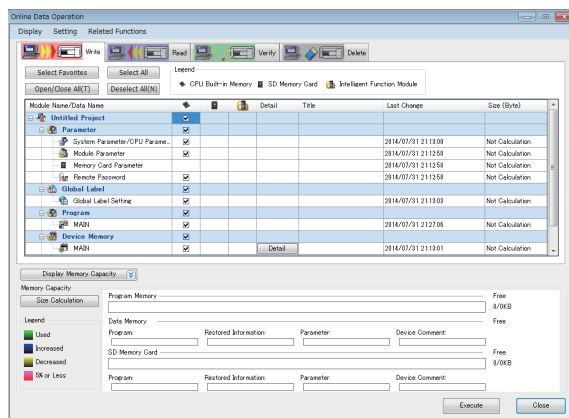

1. Select the system parameter file, CPU parameter file, module parameter file, and program file on the "Online Data Operation" window.
2. Click the [Execute] button.
3. After the write processing completes, click the [Close] button.

Point

- For the operation of the CPU module, the system parameter file, CPU parameter file, and program file must be written. For the operation of the expansion adapter, I/O modules and intelligent function modules, the module parameter files must be written as well.
- Use of the [Select Favorites] button enables users to easily select frequently-used files, such as the system parameter file, CPU parameter file, and program file. Register items as favorites on the window opened by selecting [Setting] ⇒ [Register Favorites Selection] on the menu bar.

4.11 Resetting the CPU Module

Reset the CPU module using the RUN/STOP/RESET switch located on the front of the CPU module.

Procedure

The following illustration is an example of the FX5U CPU module.

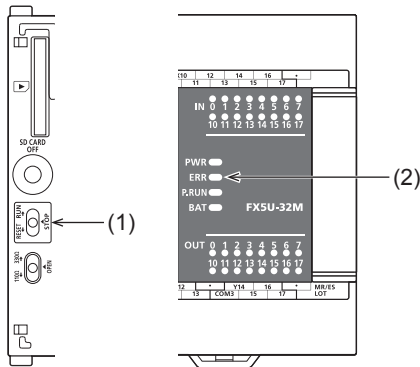

1. Set the RUN/STOP/RESET switch (1) to the RESET position for a second or longer.
2. Check that the ERROR LED (2) flashes.
3. Set the switch back to the STOP position.

Point

Operate the RUN/STOP/RESET switch with your fingers. Use of a tool such as a screwdriver may damage the switch.

4.12 Executing the Program

Execute the program written to the programmable controller by using the RUN/STOP/RESET switch.

Procedure

The following illustration is an example of the FX5U CPU module.

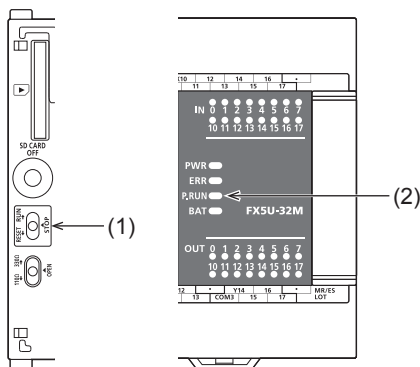

1. Set the RUN/STOP/RESET switch (1) to the RUN position.
2. Check that the P.RUN (2) turns on.

4.13 Monitoring the Program

Monitor the program operation using the engineering tool.

Monitoring on the monitor status bar

The LED status of the CPU module and the scan time can be monitored on the monitor status bar.

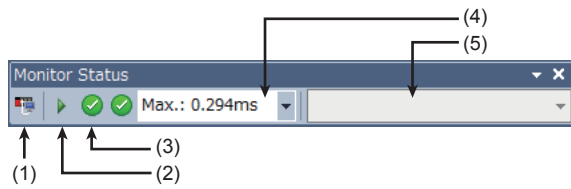

1. Select [Online] ⇒ [Monitor] ⇒ [Start Monitoring] on the menu bar.
2. Monitor the LED status of the CPU module and the scan time.

■Displayed item

No.	Item	Description	Icon	Meaning
(1)	Connection status	The connection status with the CPU module is displayed.		Connected with the CPU module
				Not connected with the CPU module
(2)	Operating status	The operating status of the CPU module in accordance with the RUN/STOP/RESET switch of the CPU module or the remote operation by the engineering tool is displayed. Click the icon. Then, "Remote operation" window appears. (GX Works3 Operating Manual)		RUN
				STOP
				PAUSE
(3)	ERROR LED status	The ERROR LED status of the CPU module is displayed. Click the icon. Then, "Module diagnostics" window appears. (Page 53 Module diagnostics)		Off
				On
				Flashing
(4)	Scan time details	The scan time details are displayed. Select the value to be displayed from the drop-down list (current value, maximum value, or minimum value).		
(5)	Monitor target selection	Specify the monitor target FB instance when monitoring a FB program.		

Monitoring on the ladder editor

The on/off states of contacts and coils and the current values of word devices and labels can be monitored on the ladder editor.

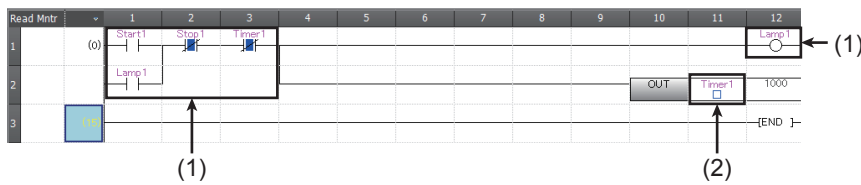

- (1) The on/off states of the contacts and coils are displayed.
- (2) The current value of the word/double word type data is displayed.

1. Select [Online] ⇒ [Monitor] ⇒ [Start Monitoring] on the menu bar.
2. Monitor the on/off states of contacts and coils and the current values of word devices and labels.

■ On/off state display

The on/off states are displayed on the editor as follows:



■ Changing the current value

To change the current value, select the cell on the ladder editor, and press **[Shift]** + double-click the cell or press **[Shift]** + **[Enter]** while the program is being monitored.

Point

The program can also be monitored on the Device/Buffer Memory Batch window of the Watch window. (GX Works3 Operating Manual)

4.14 Troubleshooting

This section describes errors that may occur during system operation, error causes, and actions to be taken.

For the troubleshooting specific to each module, refer to the manual for the module used.

Point

Saving the program and devices at the time of an error helps to analyze the error cause. (GX Works3 Operating Manual)

Troubleshooting procedure

When the system has any trouble, perform troubleshooting in the following order.

1. Check that each module is properly mounted and wired.
2. Check the LED status of the CPU module. (Page 51 Checking with LEDs)
3. Check the LED status of each intelligent function module. (User's manuals for each module)
4. Connects the engineering tool and execute the Module diagnostics function. The error cause and the action to be taken can be displayed. (Page 53 Module diagnostics)
5. If the error cause cannot be identified in steps 1 to 4, troubleshoot by symptom. (User's manuals for each module)

Checking with LEDs

Check the module status with LEDs as a means to perform the primary diagnosis.



Each LED status can be checked by using the Module diagnostics of the engineering tool.
(GX Works3 Operating Manual)

Checking the PWR LED

If the PWR LED is turned off, check the following items.

Item to check	Cause and action
Measure the voltage input to the CPU module.	If the power source is not supplying the proper voltage, provide a power source that does.
Remove extension modules and all wiring other than the one for the power supply, and turn on the power supply.	If the PWR LED turns on in this condition, the 24 V DC service power supply may be shorted or overloaded. Reconnect the modules and wire one by one to identify the cause.

If the PWR LED still does not turn on even after the items shown above are checked, there may be a hardware issue. Consult your local Mitsubishi Electric representative.

Checking the BAT LED (FX5U/FX5UC CPU module only)

If the BAT LED is flashing, check the following items.

The LED is valid when the optional battery is installed and the LED is set to "display" for battery errors by using the parameter.

Item to check	Cause and action
Check the installation of the battery.	Install the battery properly.
Check the battery voltage.	If the battery voltage is reduced, replace the battery with a new one. Battery voltage can be monitored with PLC data register SD8005. (MELSEC iQ-F FX5U User's Manual (Hardware)) (MELSEC iQ-F FX5UC User's Manual (Hardware))

Checking the ERR LED

If the ERR LED flashing, check the following items.

Item to check	Cause and action
Write system parameters, CPU parameters, and program files, and turn on the power supply again.	Programs or parameters may not written or damaged. Since a CPU module with the factory default setting has no programs, the ERR LED flashes.
Set the CPU module to the STOP status and turn on the power supply again.	When the ERR LED turns off, a watchdog timer error has probably occurred. Take any of the following measures. <ul style="list-style-type: none"> Review the program and avoid the maximum value (SD524, SD525) of the scan time exceeding the scan time monitoring time setting value set by the parameter. Check that the input used for input interruption or pulse catch is not being abnormally turned on and off in one scan. Check that the frequency of the pulse input to the high-speed counter is within the specified range. Add some WDT instructions to the program and reset the watchdog timer several times in one scan.

If the ERR LED is turned on, check the following items.

Item to check	Cause and action
Provide a different power supply to the CPU module.	If the ERR LED turns off, noise may have affected the module. Consider taking the following measures. <ul style="list-style-type: none"> Check the ground wiring, and reexamine the wiring route and installation location. Fit a noise filter onto the power supply line.

If the ERR LED still does not turn off even after the items shown above are checked, there may be a hardware issue. Consult your local Mitsubishi Electric representative.

Checking the P.RUN LED

If the P.RUN LED is turned off, check the status of the ERR LED and take corrective actions. (Page 51 Checking the ERR LED)

Troubleshooting using the engineering tool

Check the error or history using the engineering tool, and identify the error cause. More detailed information on the error as well as the error cause and action to be taken can be checked by using the engineering tool.

The engineering tool has the following functions for troubleshooting.

Function	Description
System monitor	Displays the module configuration, and detailed information and error status of each module. (Page 52 System monitor)
Module diagnostics	This function diagnoses the module. (The current error and its details can be checked.) (Page 53 Module diagnostics)
Event history	This function displays event information including errors that occurred in the CPU module, expansion board, expansion adapter, intelligent function module*1 and errors on the network. (Page 54 Event history)

*1 For supported versions of the intelligent function module, refer to Page 58 Added and Enhanced Functions.

For details on each function, refer to the following.

GX Works3 Operating Manual

System monitor

This function displays the module configuration, and detailed information and error status of each module.

For the error module identified, the module diagnostics can be executed from this window.

[Diagnostics] ⇒ [System Monitor]

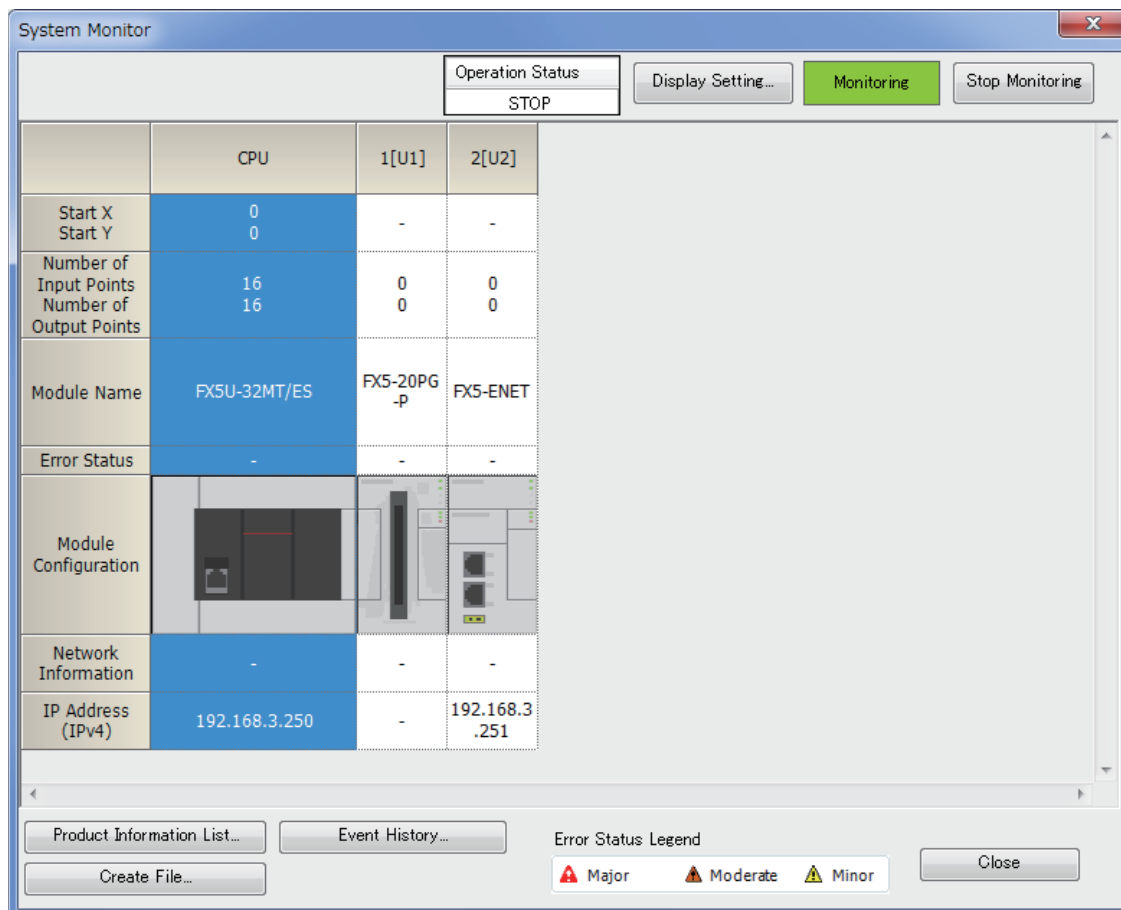

Module diagnostics

This function diagnoses CPU module expansion board, expansion adapter, and intelligent function module^{*1}. (The current error and its details can be checked.)

Information required for troubleshooting, such as the current error, details and cause of the error, and action to be taken, are displayed. The incorrect parameter setting and program error location can also be identified by selecting the error and clicking the [Error Jump] button. On the [Module Information List] tab, the LED status and the switch status of the target module can be checked.

*1 For supported versions of the intelligent function module, refer to  Page 58 Added and Enhanced Functions.

 [Diagnostics] ⇒ [System Monitor] ⇒ Double-click the error module

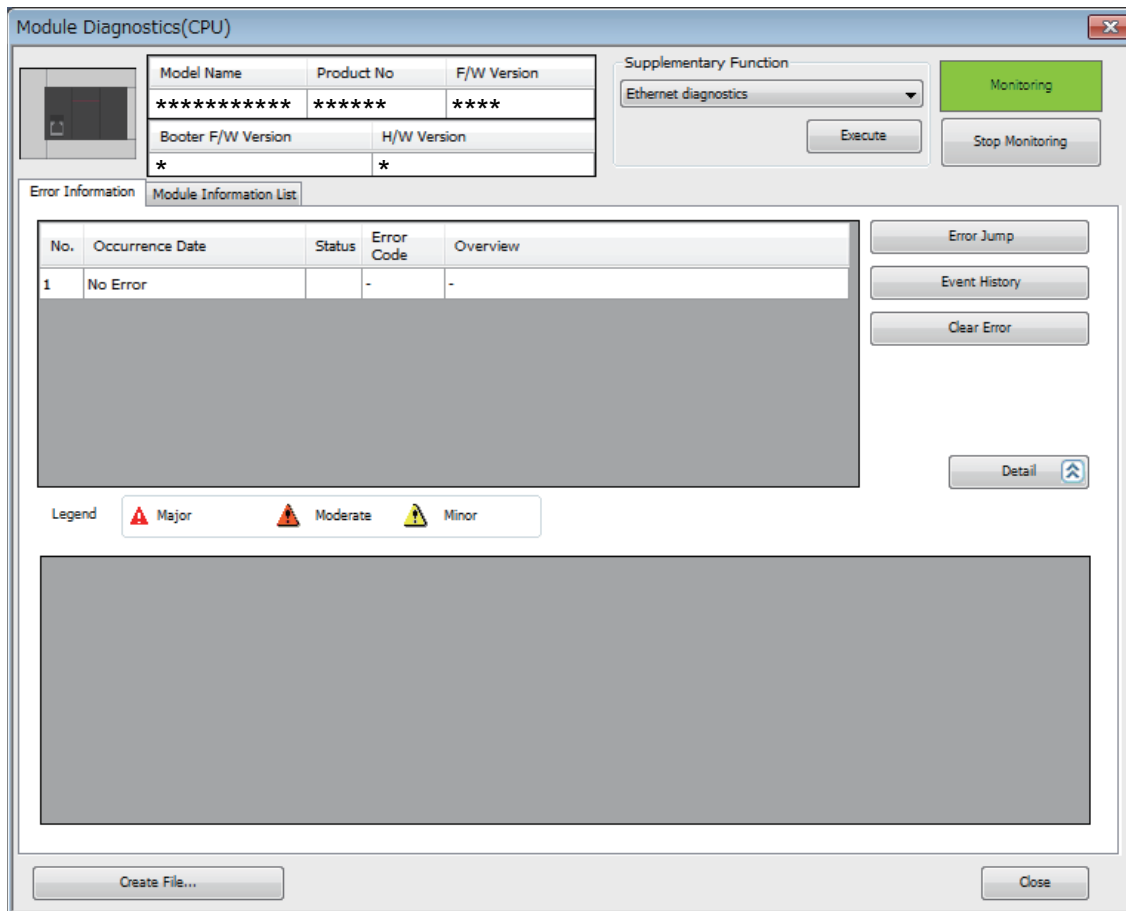

Model Name	Product No	F/W Version
*****	*****	****
Booster F/W Version	H/W Version	
*	*	

Supplementary Function: Ethernet diagnostics

Monitoring

Execute Stop Monitoring

No.	Occurrence Date	Status	Error Code	Overview
1	No Error		-	-

Legend: Major Moderate Minor

Create File... Close

Event history

This function displays the event information, such as errors that occurred in the CPU module, expansion board, expansion adapter, Intelligent function module*¹ and network errors.

Since information collected before the CPU module is powered off or reset can also be displayed, the error cause can be identified based on the errors.

The displayed information can also be saved in CSV file format.

*¹ For supported versions of the intelligent function module, refer to  Page 58 Added and Enhanced Functions.

 [Diagnostics] ⇒ [System Monitor] ⇒ [Event History] button

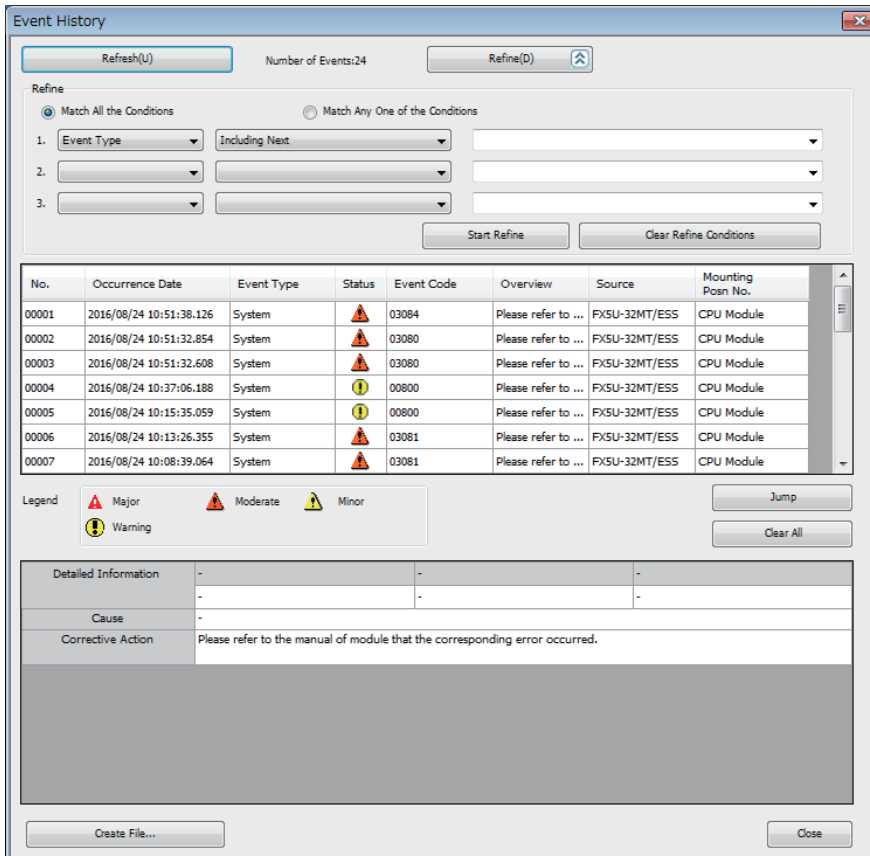

The screenshot shows the 'Event History' window with a table of events and a legend. The table has columns for No., Occurrence Date, Event Type, Status, Event Code, Overview, Source, and Mounting Postn No. The legend includes Major, Moderate, Minor, and Warning icons.

No.	Occurrence Date	Event Type	Status	Event Code	Overview	Source	Mounting Postn No.
00001	2016/08/24 10:51:38.126	System	Major	03084	Please refer to ...	FXSU-32MT/ESS	CPU Module
00002	2016/08/24 10:51:32.854	System	Major	03080	Please refer to ...	FXSU-32MT/ESS	CPU Module
00003	2016/08/24 10:51:32.608	System	Major	03080	Please refer to ...	FXSU-32MT/ESS	CPU Module
00004	2016/08/24 10:37:06.188	System	Warning	00800	Please refer to ...	FXSU-32MT/ESS	CPU Module
00005	2016/08/24 10:15:35.059	System	Warning	00800	Please refer to ...	FXSU-32MT/ESS	CPU Module
00006	2016/08/24 10:13:26.355	System	Major	03081	Please refer to ...	FXSU-32MT/ESS	CPU Module
00007	2016/08/24 10:08:39.064	System	Major	03081	Please refer to ...	FXSU-32MT/ESS	CPU Module

Legend: Major (Red triangle), Moderate (Yellow triangle), Minor (Green triangle), Warning (Yellow exclamation mark).

Buttons: Refresh(U), Number of Events:24, Refine(D), Start Refine, Clear Refine Conditions, Jump, Clear All, Create File..., Close.

Point

Use the event history function to identify the cause of failure that occurred in facilities or devices.

For details on this function and collected information, refer to the following.

 MELSEC iQ-F FX5 User's Manual (Application)

For supported versions of the event history, refer to  Page 58 Added and Enhanced Functions.

APPENDIX

Appendix 1 External Dimensions, Accessories

FX5UJ CPU module

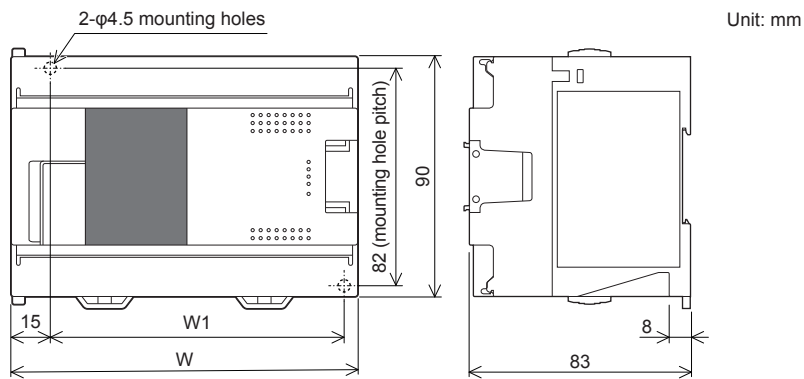

Model	W	W1 (mounting hole pitch)	Mass (weight)
FX5UJ-24MR/ES FX5UJ-24MT/ES FX5UJ-24MT/ESS	95 mm	76 mm	Approx. 0.55 kg
FX5UJ-40MR/ES FX5UJ-40MT/ES FX5UJ-40MT/ESS	130 mm	111 mm	Approx. 0.65 kg
FX5UJ-60MR/ES FX5UJ-60MT/ES FX5UJ-60MT/ESS	175 mm	156 mm	Approx. 0.80 kg

- Exterior color...Main body: Munsell 0.6B7.6/0.2
- Accessories...Dust proof protection sheet, Manual supplied with product

A

FX5U CPU module

FX5U-32M□

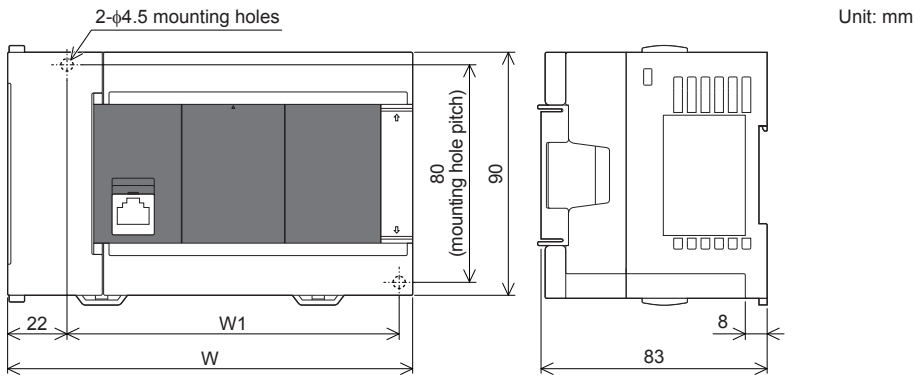

Model	W	W1 (mounting hole pitch)	Mass (weight)
FX5U-32MR/ES FX5U-32MT/ES FX5U-32MT/ESS FX5U-32MR/DS FX5U-32MT/DS FX5U-32MT/DSS	150 mm	123 mm	Approx 0.7 kg

- Exterior color...Main body: Munsell 0.6B7.6/0.2
- Accessories...Dust proof protection sheet, Manual supplied with product

FX5U-64M□, FX5U-80M□

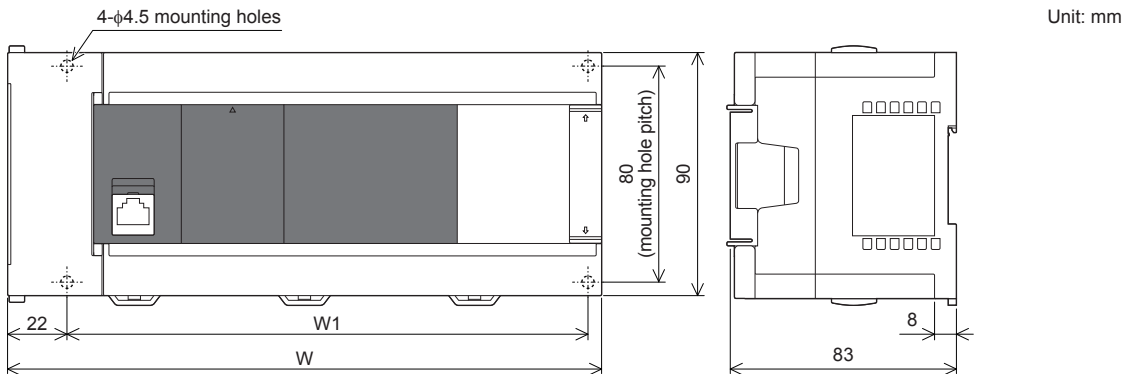

Model	W	W1 (mounting hole pitch)	Mass (weight)
FX5U-64MR/ES FX5U-64MT/ES FX5U-64MT/ESS FX5U-64MR/DS FX5U-64MT/DS FX5U-64MT/DSS	220 mm	193 mm	Approx. 1.0 kg
FX5U-80MR/ES FX5U-80MT/ES FX5U-80MT/ESS FX5U-80MR/DS FX5U-80MT/DS FX5U-80MT/DSS	285 mm	258 mm	Approx. 1.2 kg

- Exterior color...Main body: Munsell 0.6B7.6/0.2
- Accessories...Dust proof protection sheet, Manual supplied with product

FX5UC CPU module

Connector type

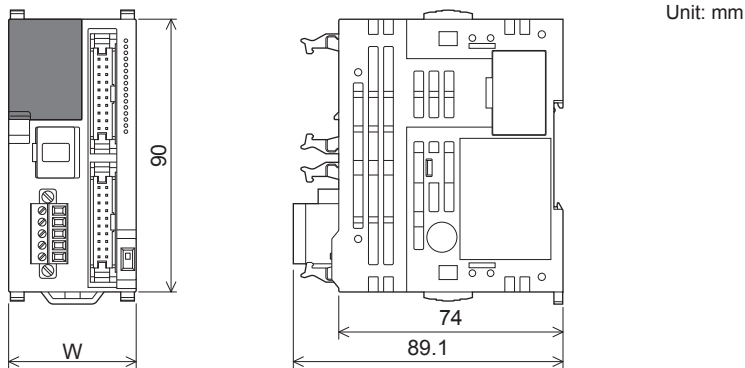

Model	W	Mass (weight)
FX5UC-32MT/D FX5UC-32MT/DSS	42.1 mm	Approx 0.2 kg
FX5UC-64MT/D FX5UC-64MT/DSS	62.2 mm	Approx 0.3 kg
FX5UC-96MT/D FX5UC-96MT/DSS	82.3 mm	Approx 0.35 kg

- Exterior color...Main body: Munsell 0.6B7.6/0.2
- Accessories...Manual supplied with product, FX2NC-100MPCB power cable: 1 m, FX2NC-100BPCB power cable: 1 m (FX5UC-□MT/D only)

Spring clamp terminal block type

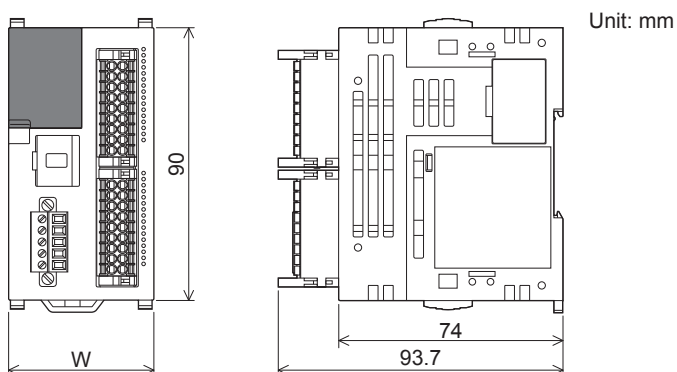

Model	W	Mass (weight)
FX5UC-32MT/DS-TS FX5UC-32MT/DSS-TS	48.1 mm	Approx. 0.25 kg
FX5UC-32MR/DS-TS	68.2 mm	Approx. 0.35 kg

- Exterior color...Main body: Munsell 0.6B7.6/0.2
- Accessories...Manual supplied with product, FX2NC-100MPCB power cable: 1 m

A

Appendix 2 Added and Enhanced Functions

The functions added or changed with the CPU module and engineering tool, and the supported CPU modules' firmware version and engineering tool software version are given below.

The firmware version can be confirmed with module diagnosis (CPU diagnosis). Refer to the following manuals for details on diagnosing the module (CPU diagnosis).

📖 MELSEC iQ-F FX5UJ User's Manual (Hardware)

📖 MELSEC iQ-F FX5U User's Manual (Hardware)

📖 MELSEC iQ-F FX5UC User's Manual (Hardware)

Refer to the 📖 GX Works3 Operating Manual for details on the software version.

FX5UJ CPU module

Add/Change Function	Supported CPU module firmware version	Supported engineering tool software version	Reference
FX5UJ CPU module is supported	From the first	"1.060N" and above	—

FX5U/FX5UC CPU module

Add/Change Function	Supported CPU module firmware version	Supported engineering tool software version	Reference
Online program change is supported.	"1.010" and above	"1.007H" and above	MELSEC iQ-F FX5 User's Manual (Application)
Diagnostics functions (Module Diagnostics) are supported.	"1.010" and above	"1.007H" and above	Page 53
Event history is supported.	"1.040" and above* ¹	"1.030G" and above	Page 52
Expanding the number of input/output points to 384 points.	"1.100" and above	"1.047Z" and above	Page 27
Removing the limitation on the number of remote I/O points. (384 points) (However, the total number of remote I/O points and input/output points is 512 points or less.)	"1.100" and above	"1.047Z" and above	Page 27
Expanding the program capacity up to 128 k steps.	"1.100" and above	"1.047Z" and above	Page 27
The following modules are supported by module diagnostics and event history function. • FX5-20PG-P* ² • FX5-20PG-D* ² • FX5-ENET • FX5-ENET/IP	"1.110" and above	"1.050C" and above	Page 52
Expanding the device/label memory from 120 kbytes to 150 kbytes.	"1.210" and above	"1.065T" and above	Page 27
SFC programs are supported.	"1.220" and above	"1.070Y" and above	Page 27 MELSEC iQ-F FX5 Programming Manual (Program Design)
Unicode character strings are supported.	"1.240" and above	"1.075D" and above	Page 27

*1 Saving the event history file to the SD memory card is supported from CPU module serial No. 16Y**** and later.

*2 Supported from the firmware version 1.010 and later of FX5-20PG-P and FX5-20PG-D.

MEMO

A

INDEX

B

BAT LED	19,22
Battery connector	20
Battery cover	24
Battery holder	20
Built-in analog function	30
Built-in analog I/O terminal block	20
Built-in Ethernet communication connector	17,19,22
Built-in Ethernet function	30
Built-in RS-485 communication terminal block	20,22
Built-in USB communication connector	17

C

CARD LED	16,19,22
CC-Link IE Field Network Basic function	30
Clock function	25,27
Command processing time	25,27
Control system	25,27
CPU module	16,19,22
CPU module fixing screw hole	18,21
Creating function blocks/functions	45

D

Data type selection window	43
DIN rail mounting groove	18,21,23
DIN rail mounting hook	16,19,23
DISP switch	23

E

ERR LED	16,19,22,51
Expansion adapter connecting hooks	16,19,22
Expansion adapter connector cover	18,21,23
Expansion board connector	17,20
Expansion board connector cover	16,19
Extension connector	17,20
Extension connector cover	16,19
Extension module connecting hook	22
External dimensions, accessories	55

F

FB instance name window	45
File storage capacity	25,27
Flash memory (Flash ROM) write count	25,27

G

Genuine product certification label	18,21,23
-------------------------------------	----------

H

High-speed input/output function	30
----------------------------------	----

I

I/O display LED	22
Input connector	22
Input display LED	16,19,23
Input terminal	23
Input/output control system	25,27

L

Label	43
Ladder entry window	44,46
LED	51

M

Memory capacity	25,27
Memory card parameter	42
Memory management window	41
MODBUS communication function	30
Module access device	26,28
Module label	37
Module parameter	42
Module parameters of the CPU module	42
Monitor status bar	49

N

Nameplate	18,21
Nameplate printing	23
No. of file register points	26,28
No. of index register points	26,28
No. of input/output points	25,27
No. of nesting points	26,28
No. of pointer points	26,28
No. of system device points	26,28
No. of user device points	26,28

O

Online data operation window	47
Operation specifications	25,27
Operation status display LED	22
Output connector	23
Output display LED	16,19,23
Output terminal	23

P

P.RUN LED	16,19,22
Peripheral device connecting connector cover	16
Power connector for CPU module	24
Power failure retention	25,27
Procedures before operation	31
Programming specifications	25,27
PWR LED	16,19,22

R

RD LED	19,22
RS-485 terminal resistor selector switch	20,24
RUN/STOP/RESET switch	17,20,23

S

SD LED	19,22
SD memory card disable switch	17,20,23
SD memory card slot	17,20,23
SD/RD LED	16,19,22
Serial communication function	30
Subsequent extension connector cover	23
System parameter	42

T

Terminal	17,20
Terminal block cover	16,19
Terminal block mounting screws	17,20
Terminal names	20,24
Top cover	19

U

Undefined label registration window	46
---	----



REVISIONS

Revision date	Revision	Description
October 2014	A	First Edition
January 2015	B	<ul style="list-style-type: none"> ■ Added or modified parts RELEVANT MANUALS, TERMS, Chapter 1, 2, 3, Section 4.1, 4.2, 4.3, 4.4, 4.5, 4.6, 4.10, 4.13, 4.14, Appendix 1, 2
April 2015	C	A part of the cover design is changed.
May 2016	D	<ul style="list-style-type: none"> ■ Added models FX5U-32MR/DS, FX5U-32MT/DS, FX5U-32MT/DSS, FX5UC-64MT/D, FX5UC-64MT/DSS, FX5UC-96MT/D, FX5UC-96MT/DSS <ul style="list-style-type: none"> ■ Added or modified parts RELEVANT MANUALS, TERMS, Chapter 3, Appendix 1
October 2016	E	<ul style="list-style-type: none"> ■ Added models FX5U-64MR/DS, FX5U-64MT/DS, FX5U-64MT/DSS, FX5U-80MR/DS, FX5U-80MT/DS, FX5U-80MT/DSS <ul style="list-style-type: none"> ■ Added or modified parts TERMS, Chapter 3, Section 2.1, 4.4, Appendix 1
August 2017	F	<ul style="list-style-type: none"> ■ Added models FX5UC-32MT/DS-TS, FX5UC-32MT/DSS-TS <ul style="list-style-type: none"> ■ Added or modified parts SAFETY PRECAUTIONS, RELEVANT MANUALS, TERMS, Section 1.2, Chapter 3, Appendix 1
July 2018	G	<ul style="list-style-type: none"> ■ Added or modified parts RELEVANT MANUALS, TERMS, Section 2.1, Chapter 3, 4, Appendix 2, 3
January 2019	H	<ul style="list-style-type: none"> ■ Added models FX5UC-32MR/DS-TS <ul style="list-style-type: none"> ■ Added or modified parts SAFETY PRECAUTIONS, RELEVANT MANUALS, TERMS, Section 1.1, 1.2, 2.1, Chapter 3, Section 4.14, Appendix 1, 3
October 2019	J	<ul style="list-style-type: none"> ■ Added models FX5UJ-24MR/ES, FX5UJ-24MT/ES, FX5UJ-24MT/ESS, FX5UJ-40MR/ES, FX5UJ-40MT/ES, FX5UJ-40MT/ESS, FX5UJ-60MR/ES, FX5UJ-60MT/ES, FX5UJ-60MT/ESS <ul style="list-style-type: none"> ■ Added or modified parts RELEVANT MANUALS, TERMS, Section 1.1, 1.2, 1.3, Chapter 2, Section 2.1, Chapter 3, Chapter 4, Section 4.2, 4.3, 4.4, 4.6, 4.7, 4.11, 4.14, Appendix 1, 3
August 2020	K	<ul style="list-style-type: none"> ■ Added or modified parts SAFETY PRECAUTIONS, WARRANTY
October 2020	L	<ul style="list-style-type: none"> ■ Added or modified parts RELEVANT MANUALS, TERMS, Section 2.1, Chapter 3, Appendix 2, TRADEMARKS
April 2021	M	<ul style="list-style-type: none"> ■ Added or modified parts RELEVANT MANUALS, TERMS, Section 2.2, Appendix 2, TRADEMARKS

This manual confers no industrial property rights or any rights of any other kind, nor does it confer any patent licenses. Mitsubishi Electric Corporation cannot be held responsible for any problems involving industrial property rights which may occur as a result of using the contents noted in this manual.

© 2014 MITSUBISHI ELECTRIC CORPORATION

WARRANTY

Please confirm the following product warranty details before using this product.

1. Gratis Warranty Term and Gratis Warranty Range

If any faults or defects (hereinafter "Failure") found to be the responsibility of Mitsubishi occurs during use of the product within the gratis warranty term, the product shall be repaired at no cost via the sales representative or Mitsubishi Service Company. However, if repairs are required onsite at domestic or overseas location, expenses to send an engineer will be solely at the customer's discretion. Mitsubishi shall not be held responsible for any re-commissioning, maintenance, or testing on-site that involves replacement of the failed module.

[Gratis Warranty Term]

The gratis warranty term of the product shall be for one year after the date of purchase or delivery to a designated place. Note that after manufacture and shipment from Mitsubishi, the maximum distribution period shall be six (6) months, and the longest gratis warranty term after manufacturing shall be eighteen (18) months. The gratis warranty term of repair parts shall not exceed the gratis warranty term before repairs.

[Gratis Warranty Range]

- (1) The range shall be limited to normal use within the usage state, usage methods and usage environment, etc., which follow the conditions and precautions, etc., given in the instruction manual, user's manual and caution labels on the product.
- (2) Even within the gratis warranty term, repairs shall be charged for in the following cases.
 1. Failure occurring from inappropriate storage or handling, carelessness or negligence by the user. Failure caused by the user's hardware or software design.
 2. Failure caused by unapproved modifications, etc., to the product by the user.
 3. When the Mitsubishi product is assembled into a user's device, Failure that could have been avoided if functions or structures, judged as necessary in the legal safety measures the user's device is subject to or as necessary by industry standards, had been provided.
 4. Failure that could have been avoided if consumable parts (battery, backlight, fuse, etc.) designated in the instruction manual had been correctly serviced or replaced.
 5. Relay failure or output contact failure caused by usage beyond the specified life of contact (cycles).
 6. Failure caused by external irresistible forces such as fires or abnormal voltages, and failure caused by force majeure such as earthquakes, lightning, wind and water damage.
 7. Failure caused by reasons unpredictable by scientific technology standards at time of shipment from Mitsubishi.
 8. Any other failure found not to be the responsibility of Mitsubishi or that admitted not to be so by the user.

2. Onerous repair term after discontinuation of production

- (1) Mitsubishi shall accept onerous product repairs for seven (7) years after production of the product is discontinued.
Discontinuation of production shall be notified with Mitsubishi Technical Bulletins, etc.
- (2) Product supply (including repair parts) is not available after production is discontinued.

3. Overseas service

Overseas, repairs shall be accepted by Mitsubishi's local overseas FA Center. Note that the repair conditions at each FA Center may differ.

4. Exclusion of loss in opportunity and secondary loss from warranty liability

Regardless of the gratis warranty term, Mitsubishi shall not be liable for compensation to:

- (1) Damages caused by any cause found not to be the responsibility of Mitsubishi.
- (2) Loss in opportunity, lost profits incurred to the user by Failures of Mitsubishi products.
- (3) Special damages and secondary damages whether foreseeable or not, compensation for accidents, and compensation for damages to products other than Mitsubishi products.
- (4) Replacement by the user, maintenance of on-site equipment, start-up test run and other tasks.

5. Changes in product specifications

The specifications given in the catalogs, manuals or technical documents are subject to change without prior notice.

6. Product application

- (1) In using the Mitsubishi MELSEC programmable controller, the usage conditions shall be that the application will not lead to a major accident even if any problem or fault should occur in the programmable controller device, and that backup and fail-safe functions are systematically provided outside of the device for any problem or fault.
- (2) The Mitsubishi programmable controller has been designed and manufactured for applications in general industries, etc. Thus, applications in which the public could be affected such as in nuclear power plants and other power plants operated by respective power companies, and applications in which a special quality assurance system is required, such as for railway companies or public service purposes shall be excluded from the programmable controller applications.
In addition, applications in which human life or property that could be greatly affected, such as in aircraft, medical applications, incineration and fuel devices, manned transportation, equipment for recreation and amusement, and safety devices, shall also be excluded from the programmable controller range of applications. However, in certain cases, some applications may be possible, providing the user consults their local Mitsubishi representative outlining the special requirements of the project, and providing that all parties concerned agree to the special circumstances, solely at the user's discretion.
- (3) Mitsubishi shall have no responsibility or liability for any problems involving programmable controller trouble and system trouble caused by DoS attacks, unauthorized access, computer viruses, and other cyberattacks.

TRADEMARKS

Anywire and AnyWireASLINK are either registered trademarks or trademarks of Anywire Corporation.

Phillips is a registered trademark of Phillips Screw Company.

Unicode is either a registered trademark or a trademark of Unicode, Inc. in the United States and other countries.

The company names, system names and product names mentioned in this manual are either registered trademarks or trademarks of their respective companies.

In some cases, trademark symbols such as [™] or [®] are not specified in this manual.

Manual number: JY997D58201M

Model: FX5-U-IN-E

Model code: 09R545

When exported from Japan, this manual does not require application to the Ministry of Economy, Trade and Industry for service transaction permission.

MITSUBISHI ELECTRIC CORPORATION

HEAD OFFICE: TOKYO BUILDING, 2-7-3 MARUNOUCHI, CHIYODA-KU, TOKYO 100-8310, JAPAN

Specifications are subject to change without notice.